

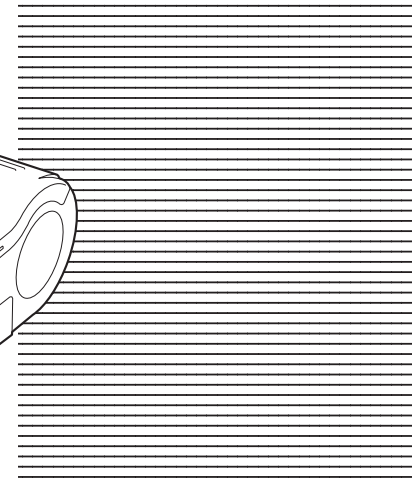

Barcode Printer
MB400i/MB410i

Quick Guide

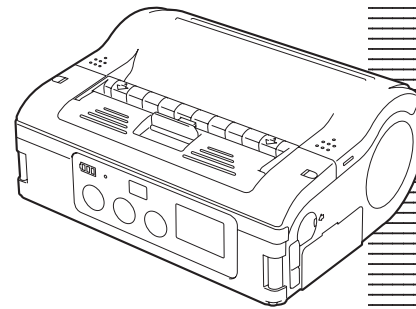

Preface

Thank you for purchasing the Barcode Printer, MB400i/410i.
This manual is created so that a first-time user of MB400i/410i can learn its basic operations in a short time.
Please read this manual carefully to make full use of the functions of MB400i/410i.

Cautions

- 1 Reproduction of all or part of this manual is prohibited.
- 2 The content of this manual is subject to change without notice.
- 3 This manual was created with utmost care regarding its content. However, if you find any unclear points, errors, or omissions, please contact the retail store or dealer where you purchased this printer.

To customers purchasing the Bluetooth or wireless LAN options:

Cautions regarding radio waves

This product is certified to meet technical standards based on the Radio Law. Therefore, no wireless license is required to use this printer.

The following actions can be punishable by law:

- Disassembly or modification of this printer
- Removing the certification label (serial label) on this printer

Use in the following locations may drastically shorten the communication distance, or prevent communication.

- Near a microwave oven; locations where static electricity or radio wave interference is abundant; near wireless LAN equipment.



"Bluetooth" is a registered trademark of Bluetooth SIG, Inc. USA.
Our company is using this trademark based on a licensing contract with this association.

Before using the wireless LAN interface, be sure to set all security-related settings for the wireless LAN equipment according to this manual.

Table of Contents

Preparation

1. Safety Precautions	4
Markings and Symbols	4
Precautions in Use	8
2. Unpacking	9
3. Names of Parts	10
Names and Functions of Operating Parts	12
4. Preparing for First-time Operation	13
Charging the Battery Pack	13
Installing and Removing the Battery Pack	15
Using AC Adapter	16
Loading Labels	17
• Continuous printing mode	17
• Dispense mode printing	19
• Switching from Dispense mode printing to Continuous printing mode	21

Operation

5. Turning the Power On	22
6. Test Printing	23
7. Operation with an RS-232C Cable	24
8. Operation with a USB Cable	25
9. Operation via Infrared Communication	26
10. Operation with Bluetooth or Wireless LAN Options	27
11. Printing	28

Troubleshooting

12. Troubleshooting	30
---------------------------	----

Care

13. Daily Care	33
----------------------	----

Reference

14. Reference	35
Included Items	35
Options	35
Operation Modes	40
DIP Switch	48
Basic Specifications of MB400i/MB410i	50

1. Safety Precautions

In this section, safety precautions about printer operation are explained to ensure proper care and usage. Make sure to read these carefully before using your printer.

Markings and Symbols

The following symbols or markings are used in this manual and on the printer so that you can properly use the printer, and to prevent any damage to property, harm or injury to yourself and others. Make sure to read their explanations carefully to familiarize yourself with their meanings.



Warning This symbol indicates information that, if ignored or applied incorrectly, creates the danger of death or serious personal injury.



Caution This symbol indicates information that, if ignored or applied incorrectly, creates the possibility of personal injury or property damage.

Symbol examples



The triangle  indicates something you should take absolute care with. The cautions are indicated concretely within the symbol. The symbol on the left indicates a risk of electric shock.



A circle with a diagonal line  indicates something you should not do. The symbol on the left indicates that you should not try to take the unit apart.





A black circle with a picture inside  indicates something you need to do. The symbol on the left indicates that you should unplug the unit from the wall outlet.

Warning

Liquid



 Do not place any container with water or chemicals, such as flower vase or cup, as well as small metallic objects, near the printer. If any of these should drop into the printer, immediately turn off the power and contact your nearest dealer or service center. Continued use creates a danger of fire or electric shock.

Foreign Matter

  Do not drop or insert metallic or flammable objects into the openings on the printer (such as outlets for cables). If any of these should fall into the printer, immediately turn off the power and contact your nearest dealer or service center. Continued use creates a danger of fire or electric shock.

 Do not touch the printer's internal parts.

Dropping and Damage

  Should the printer ever be dropped or otherwise become damaged, immediately turn off the power and contact your nearest dealer or service center. Continued use creates a danger of fire or electric shock.

 Do not touch the printer's internal parts.

Abnormal Conditions

 Continued use of the printer while it is emitting smoke or strange odors creates the danger of fire or electric shock. Immediately turn off the power and contact your nearest dealer or service center. Do not try to service the printer by yourself.



 Do not touch the printer's internal parts.



Disassembly

 Never try to take the unit apart or modify it in any way. Doing so creates the danger of fire or electric shock. Contact your nearest dealer or service center for checking, adjustment, or repair.

 Do not touch the printer's internal parts.

Battery Pack



  Never try to take apart the battery pack or modify it in any way such as with a solder iron.

  Never expose the battery to direct flame, throw it into fire, or take any actions that may lead to shorting.

 When charging the battery pack, make sure to use the printer or the specified battery charger.

Warning

AC Adapter/Battery Charger (Option)



-  • Use only the specified voltage. Using a different voltage may create the danger of fire or electric shock.
-  • Use only the specified AC adapter. Using a different one may create the danger of fire or electric shock.
-  • Never use the battery charger with any other battery pack except for the specified one. Doing so can rupture the battery, cause leakage, fire or electric shock.
- Never cut, damage or modify the power cord. Also, never place heavy objects on the power cord or heat or pull the power cord. Doing so may damage the cord and create the danger of fire or electric shock.
- Should the power cord ever become seriously damaged (internal wiring exposed or shorted), contact your nearest dealer or service center for repair. Continued use of such a cord creates the danger of fire or electric shock.
- Never modify, excessively bend, twist, or pull the power cord. Doing so creates the danger of fire or electric shock.

Caution



Location

-  Do not locate the printer in the area subjected to high humidity or dew. If dew forms inside the printer, immediately turn off the printer and do not use it until it has been dried up. Continued use creates the danger of electric shock or the printer damage.

Power

-  • Do not use wet hands to operate the power switch, replace the battery pack or unplug the AC adapter or battery charger. Doing so creates the danger of electric shock.
-  • The AC adapter set provided for this printer is specific to this printer. Do not use it for other electric equipment.



Thermal Head and Stepping Motor

-  • The thermal head gets very hot after printing. Take care when replacing the label or cleaning the printer just after printing to avoid burns.
-  • Touching the end of the thermal head with bare hands may cause injury. Take care when replacing the label or cleaning the printer to avoid injury.
- Do not try to replace the thermal head by yourself. Doing so creates the danger of injury, burns, or electric shock.

Easy Cutter

-  This part contains a blade. Take care to avoid being injured by the blade and other sharp parts in the printer.

Replacing the Battery Pack

-  • Use only the specified battery pack.
-  • When replacing the battery pack, make sure to install the pack in the correct orientation. Incorrectly replacing the battery creates the danger of injury or damage to surrounding areas, explosion is caused.
- Replacing a small-size rechargeable battery (Lithium ion battery)
Apply insulation treatment for the old battery pack by sealing the contact with tape or the like and ask our sales representative or service center for the measures to be taken to recycle the reusable materials.
Do not place the battery pack together with other batteries such as dry batteries.

Leaving the printer unused for a long time

-  If you have no plan to use the printer for a long time, remove the battery pack from the printer and unplug the AC adapter from the wall outlet.

Maintenance and Cleaning

-  For safe maintenance or cleaning of the printer, make sure to remove the battery pack and the AC adapter from the printer.

Precautions in Use

Do not place the printer in a hot or cold place.

The operation temperature range is -15°C to 50°C (for wireless LAN: 0 to 50°C) where humidity does not cause condensation. Do not place the printer in an area with high humidity or at a temperature outside the specified range.

Do not drop or apply undue shock to the printer.

The printer is generally resistant to vibration possibly caused during normal transportation. However, do not apply extreme vibration or shock by dropping the printer.

Do not disassemble or modify the printer.

The printer has high-precision components inside requiring fine adjustment. Do not disassemble the printer.

Connect the correct cables to the external input terminals.

Cables of the correct specifications are required for connection to the external equipment through the external input terminals. Contact your nearest dealer or service center if necessary.

Use the recommended accessories.

Using optional equipment other than the specified equipment may cause a malfunction. Always use the equipment specified in this guide.

Use the correct media.

Use the specified media. Otherwise, faulty printing or printer damage may occur.

1

Safety Precautions

2. Unpacking

Make sure you have all the printer components shown here. If any component is missing, contact the retail store or dealer where you purchased the product from.

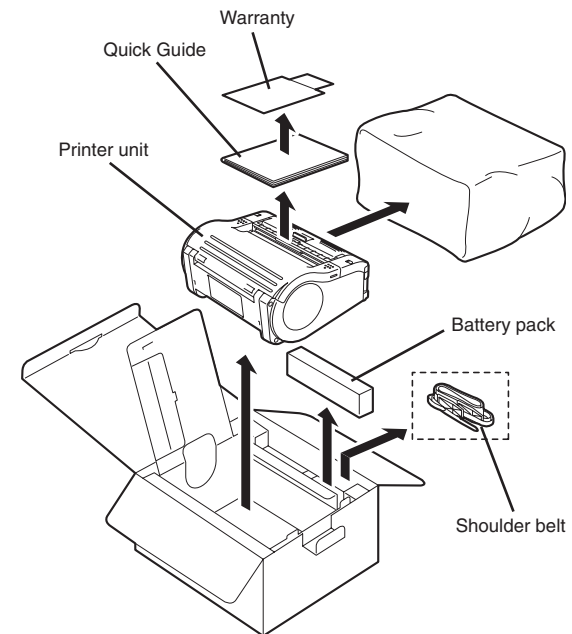

2

Unpacking

* The appearance of any cushioning material supplied (such as protector pads on the printer holder) may be changed across different production batches.

3. Names of Parts

3

Names of Parts

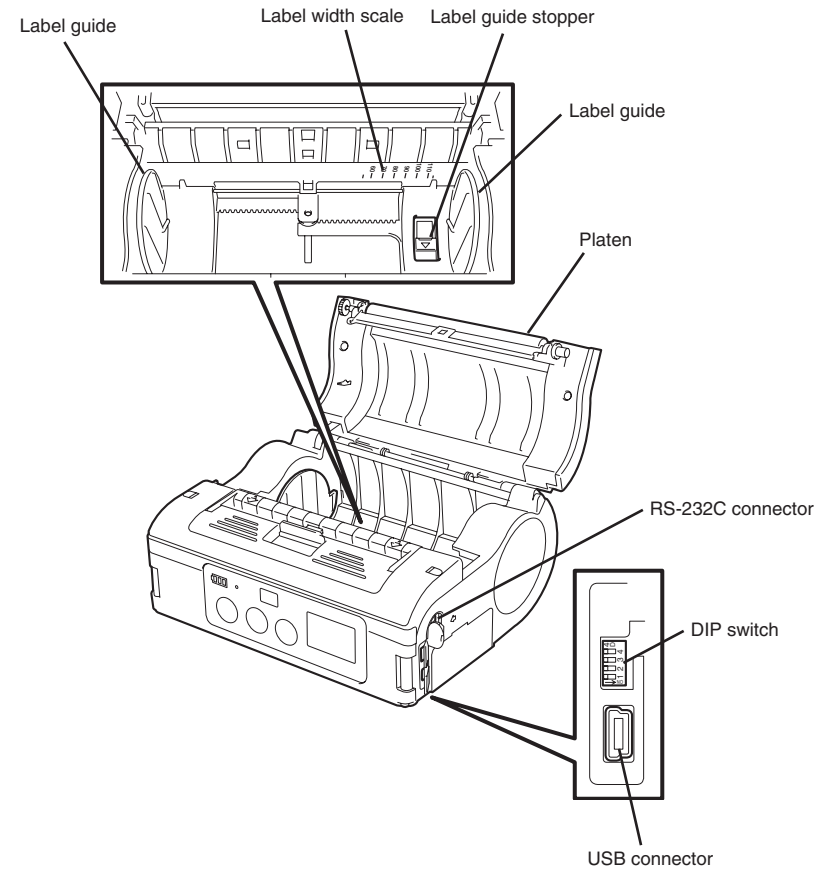
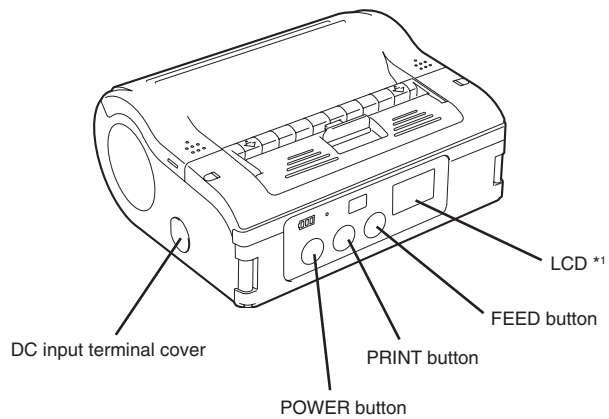
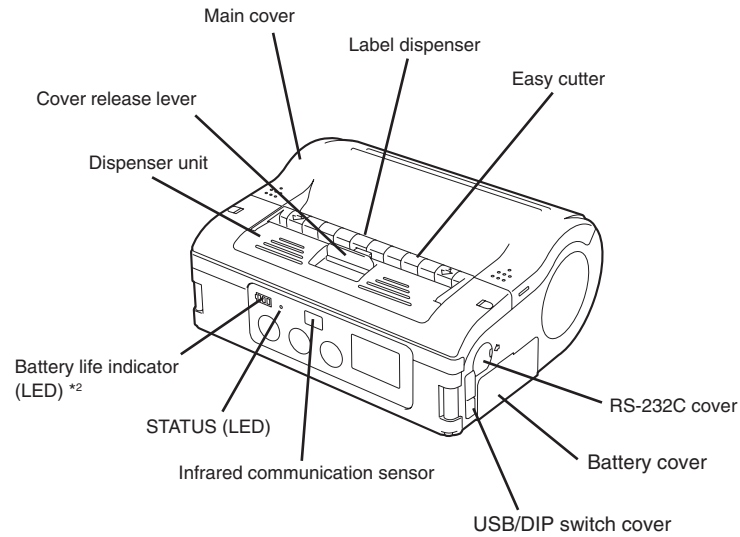

3

Names of Parts

*1 Only provided on wireless LAN interface operating panel (manufacturer option). For other options, see "Options" on page 35.

*2 On a wireless LAN interface operating panel (manufacturer option), a CHARGE LED is provided.

Names and Functions of Operating Parts

3

Names of Parts

RS-232C cover:

This covers the RS-232C connector.

RS-232C connector:

Connects with a PC etc.

USB/DIP switch cover:

Covers the USB connector and DIP switch.

USB connector:

Connects with a PC etc.

Main cover:

Open this cover to set the labels.

Cover release lever:

Use this to release the main cover.

Easy cutter:

Cuts the printed label.

Infrared communication sensor:

Contains an infrared receiver/transmitter element.

DIP switch:

Sets the operation mode. (See P. 48)

Dispenser unit:

Move this when using Dispense mode printing for the labels.

POWER button:

Turns the power on and off.

Battery cover:

A specialized battery pack is placed inside.

Battery life indicator (LED):

Displays the available battery power.

Label guide:

Set this to match the size of the label width used.

Label guide stopper:

Press this toward the back to unlock the label guide and adjust the label guide.

Label dispenser:

Printed labels are ejected here.

Label width scale:

Use this scale to match the label width used.

DC input terminal:

Connect the AC adapter.

DC input terminal cover:

Cover for the DC input terminal.

FEED button:

Feeds the labels.

PRINT button:

Takes the printer ONLINE and OFFLINE.

STATUS (LED):

Displays the printer status. (See P. 30-31 and 41-47)

4. Preparing for First-time Operation

Charging the Battery Pack

• Charging by installing the battery pack in the battery charger (optional)

Install the battery pack in the battery charger (optional) and charge it.



The optional battery charger set provided for this printer is specific to this printer. Do not use it for other electric equipment.

1

Connect the power cord to the charger unit, then plug it into the outlet.

- When charging is complete, the CHARGE lamp lights green (fully charged).

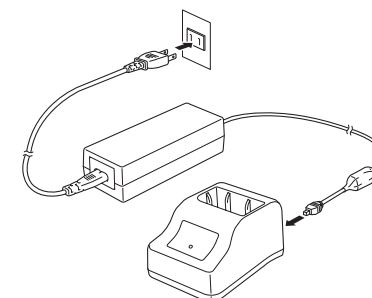

2

Insert the battery pack. Insert the battery pack into the slot, with the terminal pointing downward.

- When charging begins, the CHARGE lamp (red) lights. When charging is complete, the CHARGE lamp lights green (fully charged).

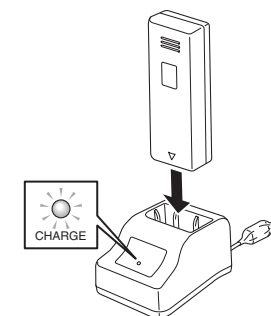

3

Remove the battery pack when charging is complete.

Charging time

It takes about 1.5 hours for the CHARGE lamp to turn off when charging a completely depleted battery.

4

Preparing for First-time Operation

Note

- When the CHARGE lamp is not lit, check that the battery pack is installed securely. The battery may not be charged when not securely installed.
- When a charged battery pack is installed, the CHARGE lamp first lights red, then lights green.

• Charging by installing the specialized AC adapter (optional) on the printer

This charges the battery pack while it is installed in the printer.

4



The AC adapter set provided for this printer is specific to this printer. Do not use it for other electric equipment.

- 1 Remove the DC input terminal cover, and insert the DC output terminal.

- 2 Plug the AC adapter into the outlet.

When charging begins, the battery life indicator lights red. When charging is complete, the battery life indicator disappears (fully charged).

* On a wireless LAN interface operating panel (manufacturer option), the CHARGE LED lights red when charging begins. When charging is complete, the CHARGE LED turns off (fully charged).

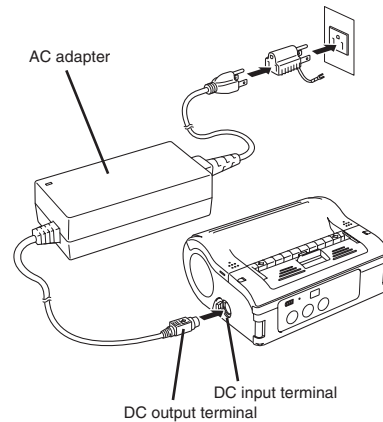

Charging time

It takes about 5 hours for the battery remaining power display to turn off when charging a completely depleted battery.

Installing and Removing the Battery Pack

- 1 Open the battery cover.

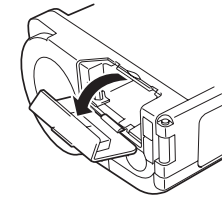

- 2 While pressing the gray hook, insert the battery pack, then close the battery cover.

Insert the battery pack with the terminal side toward the printer.

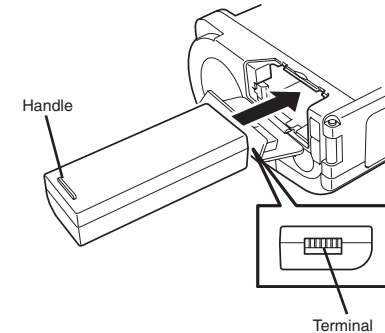

- 3 To remove the battery, press the gray hook to unlock it, then hold the handle and pull out the battery.

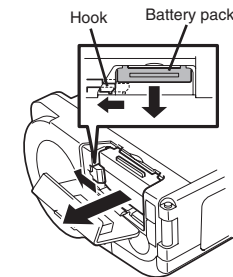

- * Be sure to turn the power off before removing or replacing the battery pack.

When the power is off, the STATUS LED turns off (see "Power OFF" on page 22). Do not remove the battery pack until this light turns off.

Make sure to check that the STATUS LED has turned off before removing the battery pack.

- * Note that removing the battery pack by the operation above may prevent updating the information in the printer memory.

Using AC Adapter

Install the specialized AC adapter (optional) on the printer for use.

 The AC adapter set provided for this printer is specific to this printer. Do not use it for other electric equipment.

- Use AC ADAPTER: Model No. TG-5001+19v (LEAD YEAR ENTERPRISE Co.,LTD.)

- 1 Remove the DC input terminal cover, and insert the DC output terminal into the input terminal.
- 2 Connect the AC adapter into the outlet.

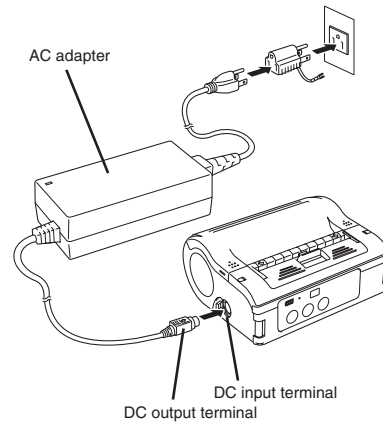

- * Be sure to turn the printer power off before detaching the DC output terminal for the AC adapter, or disconnecting the power supply.

Note that disconnecting the power supply in ways other than described above may prevent the printer from correctly storing any settings in memory.

No battery pack is necessary when the AC adapter is used. When the battery pack and AC adapter are used simultaneously, charging begins if the battery is not fully charged. The display becomes normal when fully charged (See P. 14).

Loading Labels

The label installation method differs by printing mode.

Continuous printing mode

(See figure on P. 40)

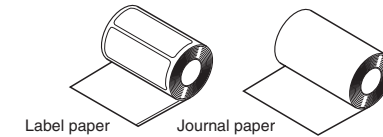

- 1 Slide the cover release lever in the arrow direction to open the cover.

First, slide the dispenser unit to the continuous printing mode position. (See P. 21)

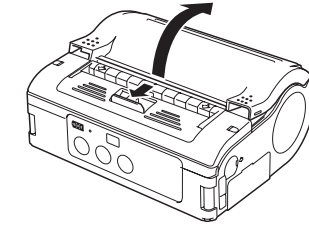

- 2 While pressing the label guide stopper, slide the label guide to the label size to be used.

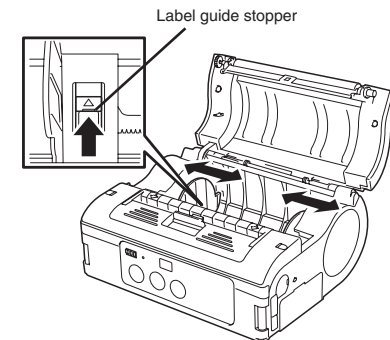

- 3 Load the paper in the printer. Make sure the roll is oriented correctly.

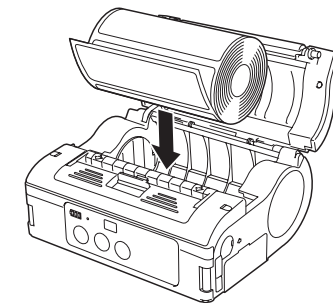

- 4 Confirm that the label roll can be rotated easily by hand.

If rotation is labored, this can cause a feed error. Remove the label roll and adjust the label guide. Note that the label guides do not require adjustment when you are using labels with the same width.

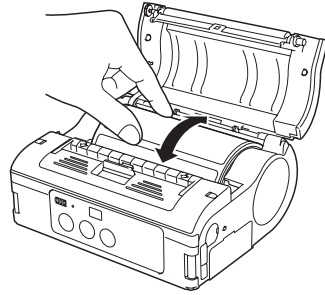

4

Preparing for First-time Operation

- 5 Check that the label tip is protruding. Then close the main cover by pressing the middle of the cover.

Close the main cover slowly, while pulling the cover release lever.

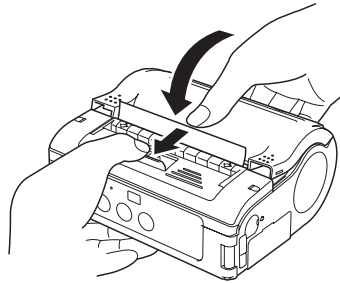

This completes loading the labels for continuous printing mode.

Dispense mode printing

(See figure on P. 40)

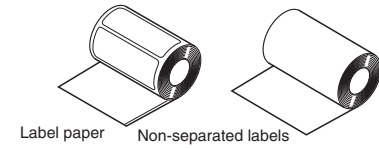

- 1 Slide the cover release lever in the arrow direction to open the cover.

First, slide the dispenser unit to the continuous printing mode position. (See P. 21)

* Never slide the dispenser unit while the main cover is open.

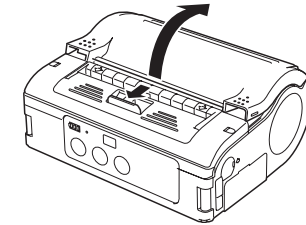

- 2 While pressing the label guide stopper, slide the label guide to the label size to be used.

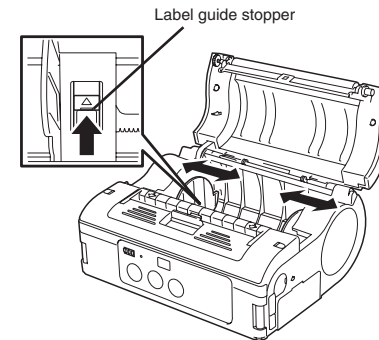

- 3 Peel the label at the tip of the label paper.

Dispense mode printing is not required for non-separated labels.

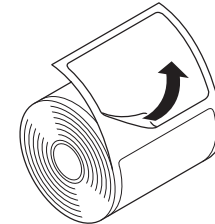

4

Preparing for First-time Operation

- 4 Load the paper in the printer.
Make sure the roll is oriented correctly.

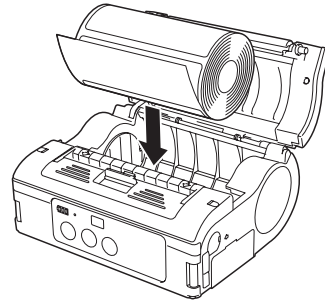

- 5 Confirm that the label roll can be rotated easily by hand.

If rotation is labored, this can cause a feed error. Remove the label roll and adjust the label guide. Note that the label guides do not require adjustment when using labels with the same width.

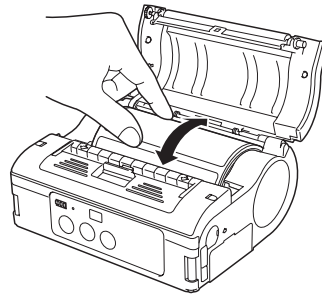

- 6 Check that the label tip is protruding (10 mm or more). Then close the main cover by pressing the middle of the cover. Close the main cover slowly, while pulling the cover release lever.

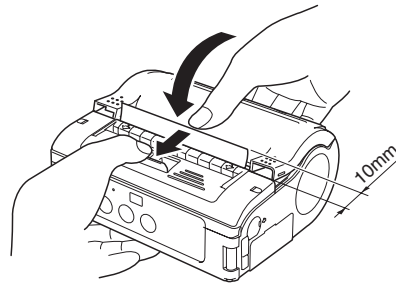

- 7 For non-separated labels, press the FEED button to feed one sheet, and pull upward to tear along the perforated line.

If the labels clog at the label dispenser, restart the label loading process from the beginning.

- 8 Slide the dispenser unit until it stops.

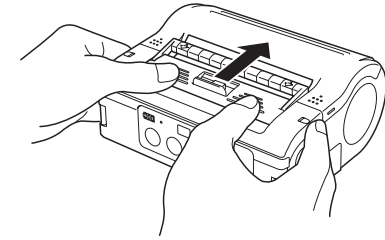

This completes loading of the labels for dispense mode printing.

• **Switching from Dispense mode printing to Continuous printing mode**

Holding the dispenser/continuous switching lever upward, slide the dispenser unit toward you. Never pull it with the lever still engaged. This may damage the dispenser unit.

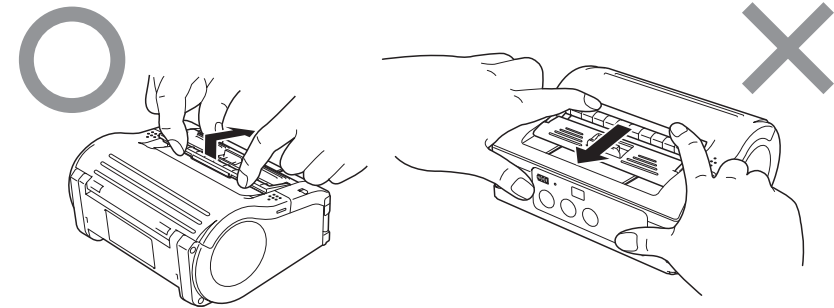

When using dispense mode printing, be sure to follow the procedure above to switch the dispenser unit from dispense mode printing to continuous printing mode, before changing the paper.

5. Turning the Power On

When the preparation steps are complete, turn the power on or off.

Power ON

- 1 Hold down the POWER button until the STATUS LED lights green. Then release the POWER button.

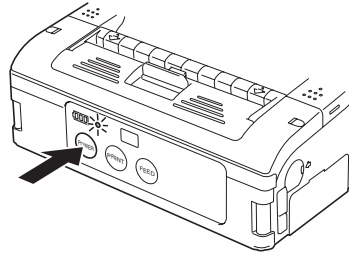

Power OFF

- 2 Hold down the POWER button again, until the STATUS LED turns off. Then release the POWER button.

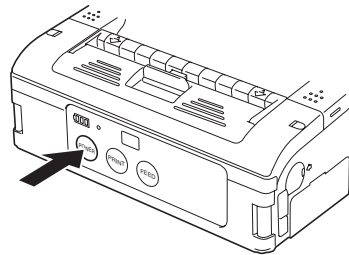

5

Turning the Power on

6. Test Printing

- 1 When pressing the FEED button and holding down the POWER button simultaneously, the printer enters the test mode. Press the FEED button again to start test printing.

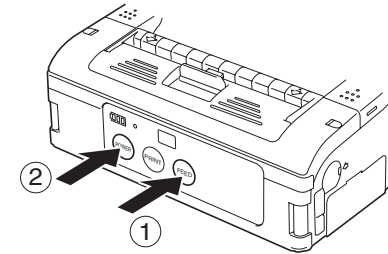

- 2 Verify the following using the output of the test print.
 - There are no chipped characters.
 - Printing condition is good.

In test printing, the estimated remaining battery power is displayed as "■■■". (■■■ when completely charged.) When the remaining battery power is ■■, charge the battery.

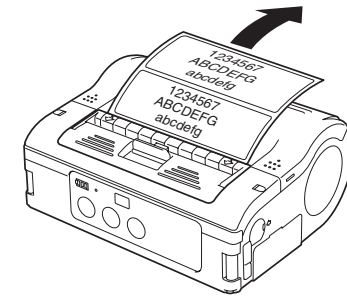

6

Test Printing

* If a problem occurs, contact the retail store or dealer where you purchased the printer from, or our sales personnel or service center.

7. Operation with an RS-232C Cable

To print with an optional RS-232C cable connected to a PC or a handheld terminal, perform the following operations.

- 1 Remove the USB/DIP switch cover, and set the DIP switch (DSW) to DSW-1, 2, 3, 4 = (OFF, OFF, OFF, OFF).

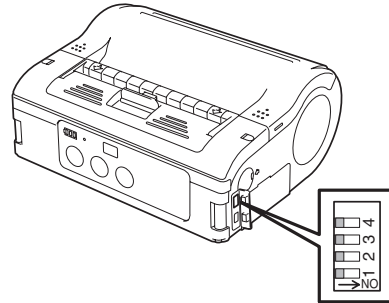

- 2 Remove the RS-232C connector cover.

- 3 Insert the RS-232C cable into the connector.

Match the arrow on the RS-232C cable connector with the arrow beside the printer connector, and insert it firmly.

- 4 Connect the other end of the RS-232C cable to the connector on the PC or the handheld terminal.

For the connector on the PC or the handheld terminal, see the manuals provided with that equipment.

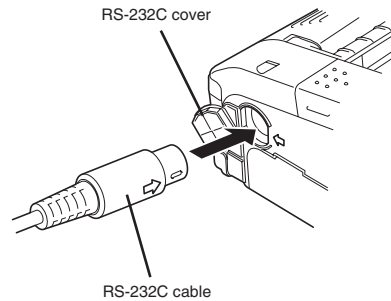

7

Operation with an RS-232C Cable

8. Operation with a USB Cable

To print with an optional USB cable (mini B type) connected to a PC or a handheld terminal, perform the following operations.

- 1 Remove the USB/DIP switch cover, and set the DIP switch (DSW) to DSW-1, 2, 3, 4 = (ON, ON, OFF, OFF).

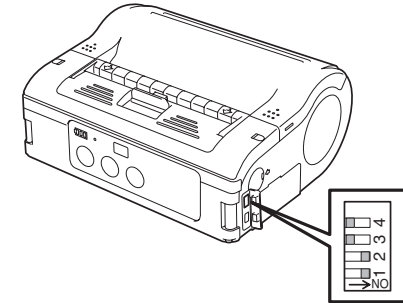

- 2 Insert the USB cable into the connector.

Match the arrow on the USB cable connector with the arrow beside the printer connector, and insert it firmly.

- 3 Connect the other end of the USB cable to the connector on the PC or the handheld terminal.

For the connector on the PC or the handheld terminal, see the manuals provided with that equipment.

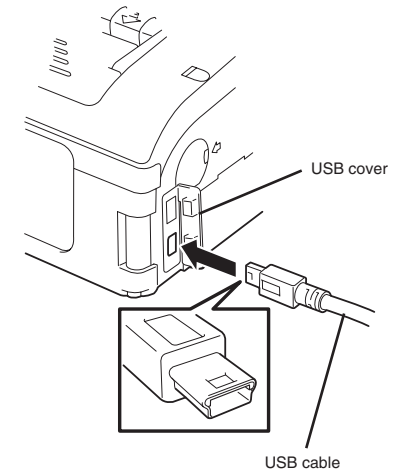

8

Operation with a USB Cable

9. Operation via Infrared Communication

To print using infrared communication, perform the following operations.

1 Remove the USB/DIP switch cover, and set the DIP switch (DSW) to DSW-1, 2, 3, 4 = (ON, OFF, OFF, OFF).

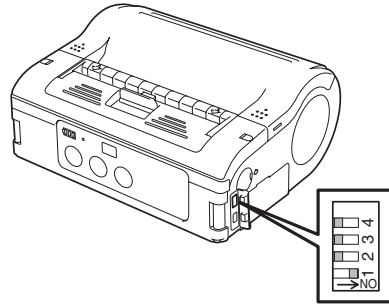

2 Place the printer within 20 cm of the PC or handheld terminal for infrared communication.

3 Adjust the printer position so that the PC or handheld terminal is within a 30° area vertically and horizontally (cone shape) from the center of the infrared communication sensor.

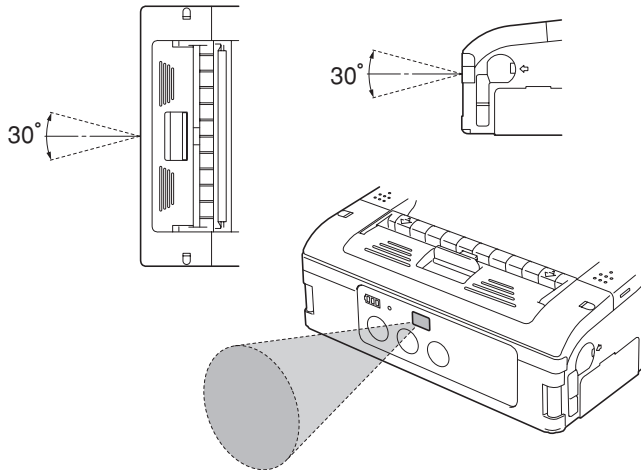

The maximum usage distance for infrared communication is 15 to 20 cm.

* However, this differs with the usage environment and the communicating equipment. Communication may not be possible in direct sunlight or under powerful illumination. In such cases, either shield the infrared communication sensor from harsh light, or place the infrared communication sensor in contact with the communicating equipment.

10. Operation with Bluetooth or Wireless LAN Options

To print using a Bluetooth interface or a wireless LAN interface, perform the following operations.

1 Remove the USB/DIP switch cover, and set the DIP switch (DSW) to DSW-1, 2, 3, 4 = (OFF, ON, OFF, OFF).

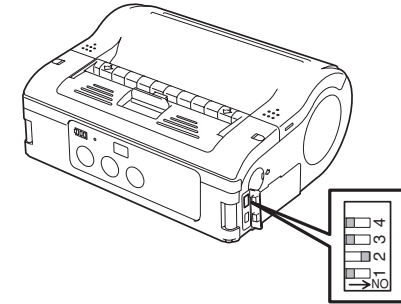

* Note that the effective distance varies with the usage environment, computer, or handheld terminal in use.

9

Operation via Infrared Communication

10

Operation with Bluetooth or Wireless LAN Options

11. Printing

- 1 Data is sent from a PC.
- 2 When printing is complete, hold the right or left corner of the label, pull it in the direction of the arrow, and tear the label.

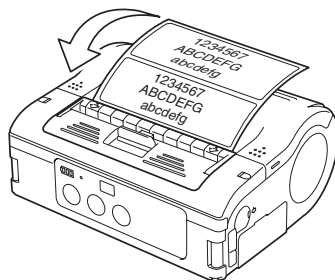

11

Printing

- * The number of labels that can be printed with one battery pack differs between continuous printing mode and dispense mode printing.
- * When the non-separated labels are severed somewhere other than the perforated line, and the next label is not printed, perform the operations on page 29.

■ When the next label is not printed

- 1 With the printer online, press the PRINT button to take the printer offline (STATUS LED turns off).
- 2 Press the FEED button to feed the labels.
- 3 When the paper stops, pull it in the direction of the arrow to cut the label.
- 4 Press the PRINT button to put the printer online (STATUS LED lights green).

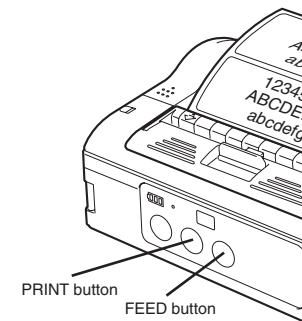

PRINT button

FEED button

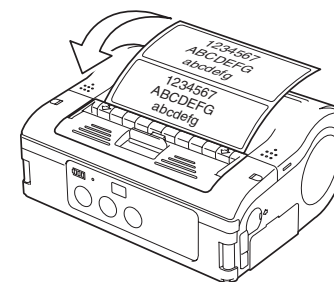

11

Printing

12. Troubleshooting

The status of this printer is indicated by the STATUS LED display and a buzzer sound. When the STATUS LED display or buzzer indicates the status below, the

printer is in an abnormal condition. Clear the error using the clearing method. The printer will automatically turn off in about 30 seconds after a low battery display appears. Confirm that the power is off, then remove the battery pack and charge it.

STATUS LED/buzzer	Mode	Content		Cause	Clearing method
LED: ON (red)	All modes	Low battery	⇒ ⇒	① The battery is not fully charged.	① Charge the battery.
LED: Blinking (red) every 2 seconds Buzzer: One long beep	Online	Module error (Bluetooth or wireless LAN)	⇒ ⇒	① Interface module is in abnormal condition. (Bluetooth or wireless LAN)	① Replace the board.*
LED: ON (red)	After turning power on	① Program abnormality error ② FLASH ROM error	⇒ ⇒	① A FLASH ROM reading/writing error has occurred.	① Replace the FLASH ROM.* ② Re-download the program.*
LED: Two colors blinking alternately (green → red) every 2 seconds Buzzer: One long beep	Online	Head error	⇒ ⇒	① The head has a broken wire.	① Replace the head.*
LED: Blinking (red) every 0.5 seconds Buzzer: Three short beeps	Online	Cover open	⇒ ⇒	① The cover is not locked. ② Cover opening/closing sensor is in abnormal condition.	① Lock the cover. ② Adjust the sensor.*
		Out of paper	⇒ ⇒	① Out of labels.	① Set a new roll of label.
		Sensor error	⇒ ⇒	① The sensor level is incorrect. ② The sensor type is incorrect. ③ The paper is misrouted.	① Adjust the sensor level.* ② Match the sensor type. ③ Remove the label roll and place it correctly.
LED: Blinking (green) every 1 second Buzzer: One long beep	Online	Communication error	⇒ ⇒	① The communication conditions are incorrect. ② Cable connection is in abnormal condition.	① Correct the communication conditions. ② Check the cable connections.
LED: Blinking (green) every 0.5 seconds Buzzer: One long beep	Online (printing or receiving data)	Buffer almost full	⇒ ⇒	① The receiving buffer is running out of capacity.	① Pause host data transmission, wait for the buffer to empty, then retransmit data.
LED: Blinking (red) every 4 seconds Buzzer: One long beep	Online (printing or receiving data)	Buffer overflow	⇒ ⇒	① Data has exceeded the receiving buffer capacity. ② The communication conditions are incorrect.	① Transmit data corresponding with the communication conditions. ② Correct the communication conditions.
LED: Blinking (green) every 2 seconds	All modes	Sleep mode	⇒ ⇒	① This is not an error. The printer is operating in low power consumption mode.	① Clear by pressing a button, receiving data, or opening/closing the main cover.
LED: Patterned lighting (red → OFF → green → OFF) every 1 second	All modes	Head overheating protection function	⇒ ⇒	① This is not an error. The head overheating protection function operates when the head temperature exceeds 70°C.	① This is cleared when the head temperature falls to 55°C.
LED: Two colors blinking alternately (green → orange) every 0.5 seconds	Online (automatic dispenser printing or dispenser operation 2)	Manual dispensing mode	⇒ ⇒	① This is not an error. ② Press the PRINT button to print one label.	① Automatically cleared when the designated number of labels are printed.

* : Contact your nearest service center or retail store.

■ When printing fails (automatic printing)

In direct sunlight or under illumination, the internal sensors may mis-operate (assuming a label is present in the dispenser unit), and prevent printing. In such malfunction, either shield the dispenser unit from harsh light, or operate using one of the following methods.

① Operation using manual printing

Switch to manual printing by specifying the dispenser operation mode. (See P. 43)

② Operate using operation 2 for the dispenser operation

Using the printer setup tool, switch the dispenser operation to operation 2. When operation 2 is set for the dispenser operation, if harsh light is preventing printing, print using the following procedure.

Press the PRINT button to switch to manual printing, and print one label. When printing multiple labels, operate with manual printing until the designated number of labels are printed.

While operating in manual printing mode, the STATUS LED alternates between lighting green and orange (every 0.5 seconds).

Print condition	Cause	Countermeasures
Smudged	① The head is dirty. ② The rollers are dirty.	① Clean the head (See P. 33). ② Clean the platen (See P. 34).
Vertical stripes	① The head is dirty. ② The head is defective.	① Clean the head (See P. 33). ② Replace the head.*
Characters printed diagonally	① The label guide position is incorrect. ② The rollers are dirty.	① Reset the label (See P. 17). ② Clean the platen (See P. 34).
Blank (not printed)	① The RS-232C/USB cable connection is poor. ② Infrared communication error. ③ Bluetooth/wireless LAN communication error. ④ The DIP switch settings are incorrect. ⑤ The head is defective.	① Check the RS-232C/USB cable connections (See P. 24 and 25). ② The distance between the PC and the printer should be within 15-20 cm. In addition, check that the PC is within a 30° area vertically and horizontally (cone shape) from the center of the printer infrared communication sensor (See P. 26). ③ Check all settings. ④ Check the DIP switch settings (See P. 48). ⑤ Replace the head.*

* : Contact your nearest service center or retail store.

13. Daily Care

Be sure to turn the power off and remove the battery pack before performing the following operations.

■ Caring for the thermal head

- Slide the cover release lever to open the cover.

When in dispense mode printing, first slide the dispenser unit to the continuous printing mode position. (See P. 21)

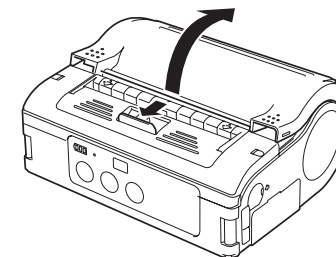

- Wipe off any smudges with a cloth dipped in alcohol.

* Do not use thinner, benzene, or kerosene.

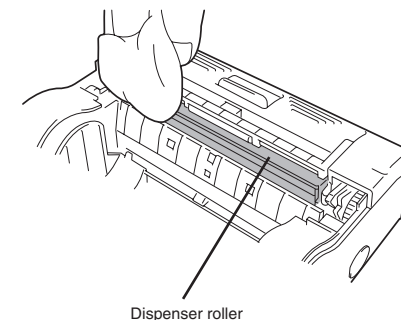

Dispenser roller

■ Caring for the platen/ dispenser roller/paper sensor

- 1 Slide the cover release lever to open the main cover.

When in dispense mode printing, first slide the dispenser unit to the continuous printing mode position. (See P. 21)

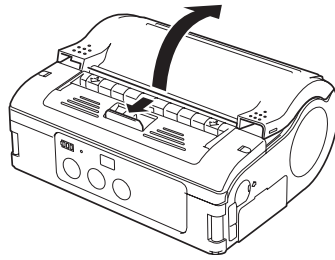

13

Daily Care

- 2 Wipe off any smudges with a cloth dipped in alcohol.

* Do not use thinner, benzene, or kerosene.

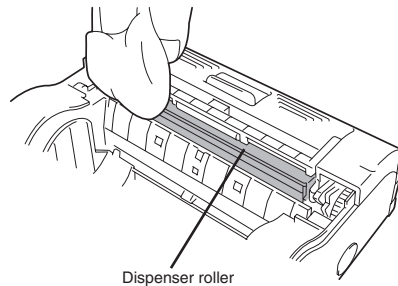
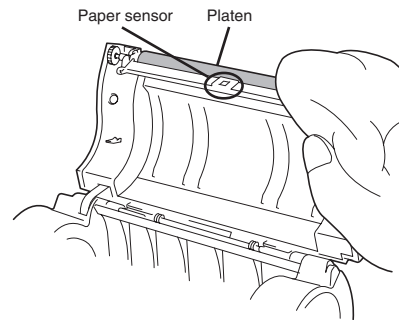

14. Reference

Included Items

- **Shoulder belt**

This belt allows you to carry the printer on your shoulder.

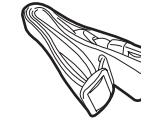

- 1 Thread the shoulder belt through the belt holes on the printer, from the outside to the inside.

- 2 Thread the end of the shoulder belt through the buckle, and adjust the length.

* If the belt is not routed correctly, the belt may detach and the printer may drop.

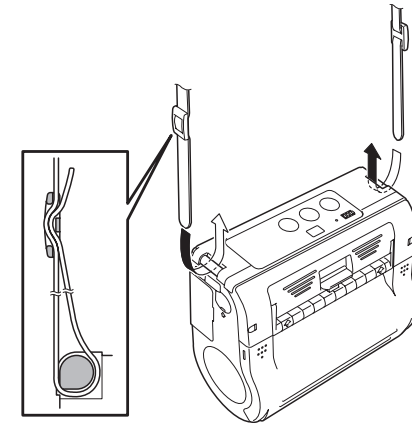

14

Reference

Options

User options

- **Battery pack (one pack provided with this printer)**

Having extra batteries available will minimize work interruptions caused by depleted batteries.

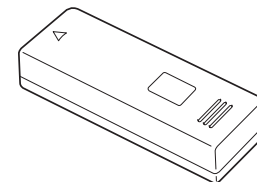

- **Battery charger (single)**
This charges a single battery pack.

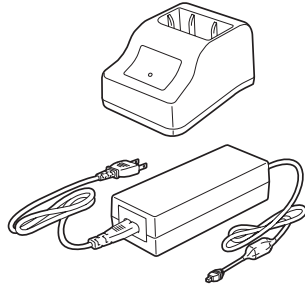

14

Reference

- **Battery charger (quintuple)**
This charges multiple battery packs (maximum of five).

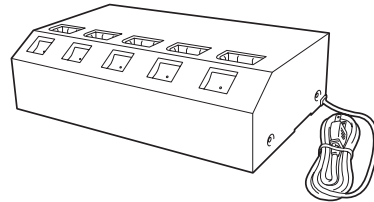

- **AC adapter for printer**
Use this to supply power from a household power outlet (AC100V or 240V).
Connect the DC output terminal of the AC adapter to the printer.

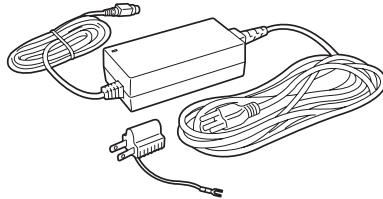

- Be sure to use the specified adapter.
- Hold the printer when connecting or disconnecting.
- Be careful not to damage the cord.
- Unplug for storage when not in use.
- The AC adapter set provided for this printer is specific to this printer. Do not use it for other electric equipment.

- **Shoulder case with rainproof cover**
This is a version of the Belt case that has a rainproof cover.

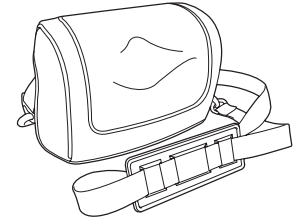

Fastening method

- 1 Open the cover and place the printer in with the operating parts facing up.

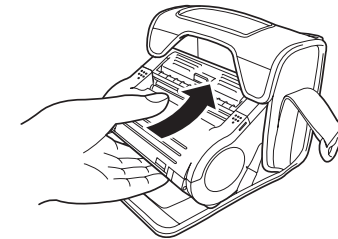
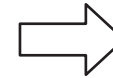
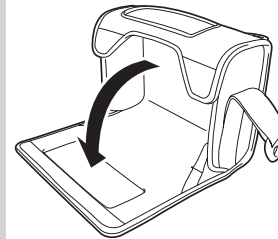

- 2 Place the lower side in the case so that the printer is completely in the case.

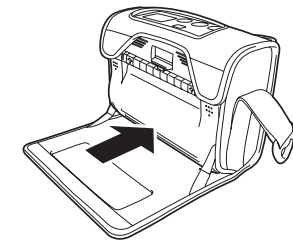

- 3 Close the cover.

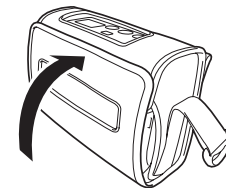

14

Reference

- 4 Affix the rainproof cover to the Belt case with the buttons and set in place.

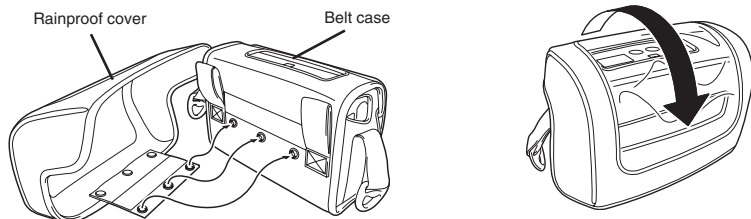

14

- 5 Attach the shoulder strap to the rainproof case.

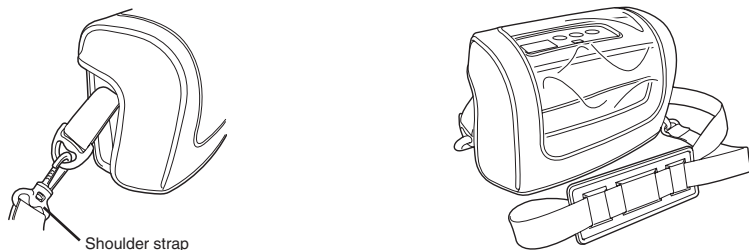

Reference

• **Belt case**

This protective case is for carrying the printer by attaching it to your belt.

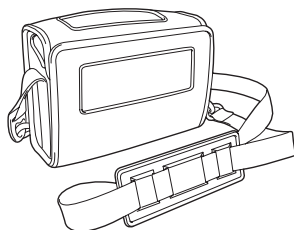

Fastening method

- 1 Open the cover and place the printer in with the operating parts facing up.

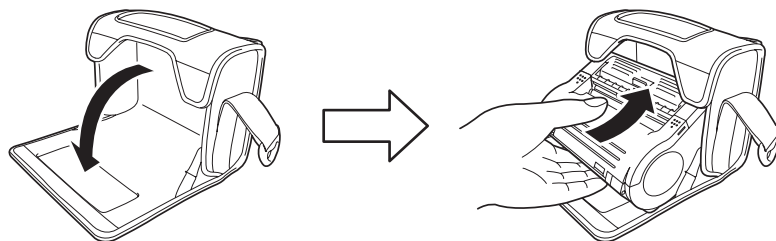

38

- 2 Place the lower side in the case so that the printer is completely in the case.

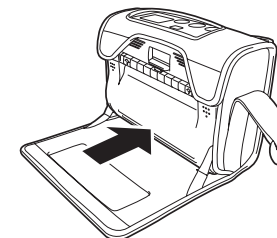

- 3 Close the Belt case cover.

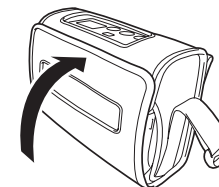

- 4 Run a belt through the Belt case.

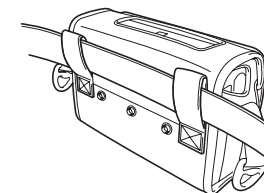

14

Reference

• **RS-232C cable**

This connects with a PC or handheld terminal.

• **USB cable**

This connects with a PC or handheld terminal.

Manufacturer options

• **Wireless LAN interface operating panel (with LCD)**

This is an operating panel with an LCD to display the wireless communication status.

39

Operation Modes

There are two printer operation modes: continuous printing mode, and dispense mode printing. Test printing and online printing are available in both modes.

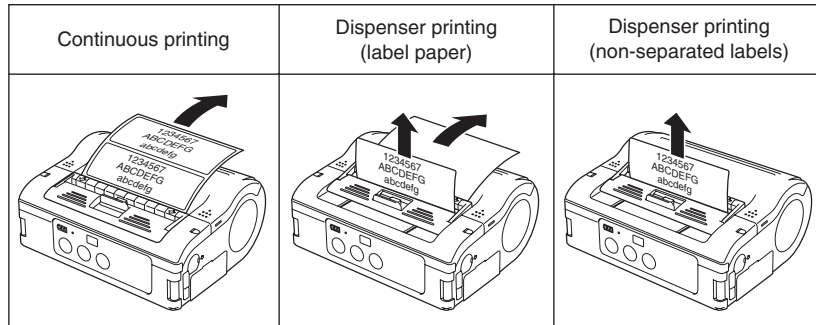
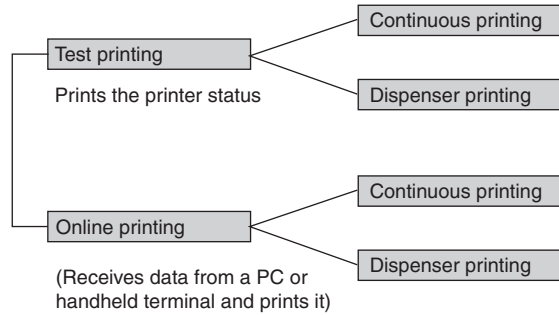

* Use the printer setting tool to set dispense mode printing (non-separated labels).

Normal operation mode

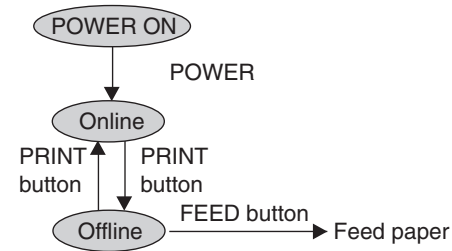

The LED display for the normal operation mode is as follows.

Operation status	STATUS (LED)
Starting normal printing mode	ON (orange)
Online	ON (green)
Offline	OFF

* When the buzzer sound mode is enabled, the buzzer sounds upon startup. The battery life indicator remains on even when the printer is OFFLINE.

Power saving mode

1. Sleep mode:

With the printer online, the STATUS (LED) blinks (green) every two seconds. When offline, the STATUS (LED) is off. The battery life indicator (LED) remains on even when the printer is OFFLINE.

The printer enters sleep mode (standby status) when it has not been operated for five seconds.

Normal status is resumed by pressing the PRINT button or the FEED button, by receiving data, or by opening and closing the main cover.

Test printing mode (FEED button + POWER ON)

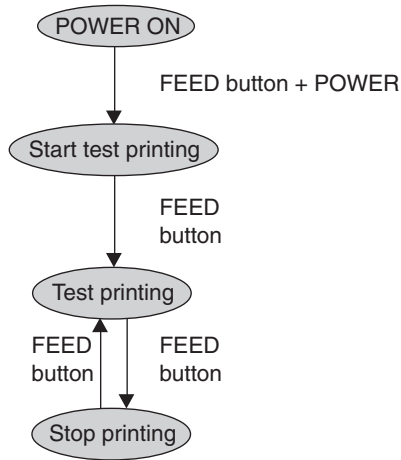

14

Reference

The LED display for the test printing mode is as follows.

Operation status	STATUS (LED)
Starting test printing mode	ON (orange)
Test printing initializing	Blinking (green)
Test printing	ON (green)
Stop printing	OFF

* When the buzzer sound mode is enabled, the buzzer sounds upon startup. Release the FEED button to stop the buzzer.

Dispense mode printing

Dispense mode printing setting

Type	Operation	Default
Automatic printing setting	Prints one label after receiving data, then waits for label to be peeled. After the label is peeled, the next label is printed automatically.	Manual printing setting
Manual printing setting	Prints one label after receiving data, then enters offline status. When the PRINT button is pressed, the next label is printed. After the specified number of labels are printed, printing is ended, and no labels are printed when the PRINT button is pressed.	

14

Reference

Changing the dispense mode printing setting

The dispenser operation mode setting is changed by the DIP switch (DSW) settings when the power is turned on, and by button settings. The settings are enabled upon turning the power off.

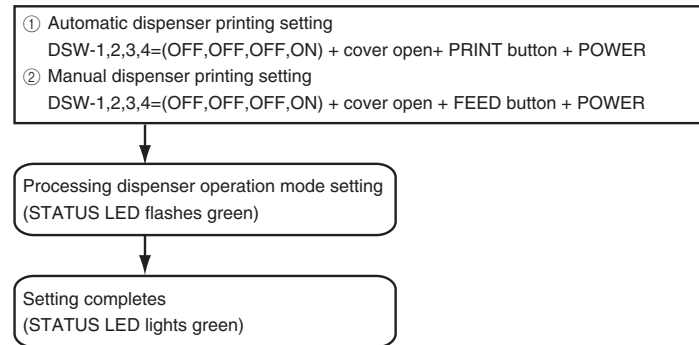

Note: When the buzzer sound mode is enabled, the buzzer sounds upon startup. Release the PRINT/FEED button to stop the buzzer. To end the dispenser operation mode setting, confirm that the STATUS LED is on in green, then turn the power off. After changing the dispenser operation mode setting, be sure to restore the DSW to their original settings.

Head check setting mode

In the head check setting mode, a check can be performed in two checking areas: the printing area and the barcode printing area.

The presence of the head check function and the head check range settings are set by the DIP switch (DSW) settings when the power is turned on, by button pressing status, and by the cover status.

DIP switch settings

	DSW-1	DSW-2	DSW-3	DSW-4
(A)	OFF	ON	OFF	ON
(B)	ON	OFF	OFF	ON

DSW settings	Button and cover status	Function	Default
(A)	PRINT button + cover open	Head check range set as printing area	Head check range set as printing area
	FEED button + cover open	Head check function set as disabled	
(B)	PRINT button + cover open	Head check range set as barcode printing area only	
	FEED button + cover open	Head check function set as disabled	

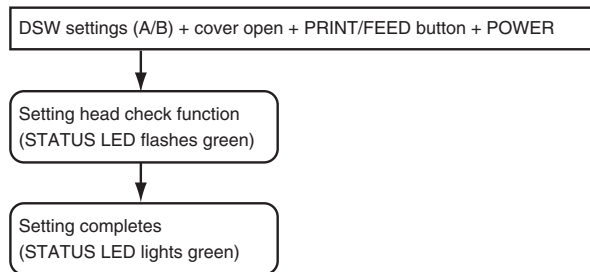

Note: When the buzzer sound mode is enabled, the buzzer sounds upon startup. Release the PRINT/FEED button to stop the buzzer. To check the settings for head check setting mode, see the test print output (See P. 23). To end head check setting, confirm that the STATUS LED is on in green, then turn power off. After changing the head check setting mode, be sure to restore the DSW to their original settings.

Online command setting mode

Online command setting details

Type	Operation	Default
MB400 compatibility command setting	Sets the online command as standard legacy command (of the MB200/400 series).	SBPL command setting
SBPL command setting	Sets the online command as an SBPL command.	

Change online command setting

The online command setting is changed by the DIP switch (DSW) settings when the power is turned on, and by button settings. The settings are enabled upon turning the power off.

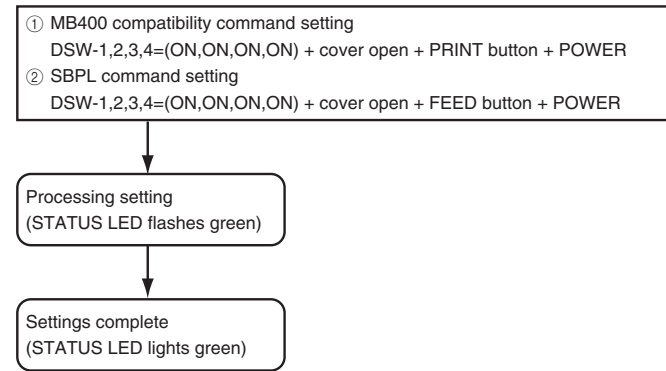

Note: When the buzzer sound mode is enabled, the buzzer sounds upon startup. Release the PRINT/FEED button to stop the buzzer. To check the settings for the online command setting mode, see the test print output (See P. 23). To end online command setting, confirm that the STATUS LED is on in green, then turn the power off. After changing the online command setting mode, be sure to restore the DSW to their original settings.

Buzzer sound mode setting

A buzzer can be sounded upon starting up the printer and upon errors. The buzzer is enabled by default. This can be enabled or disabled by the initial operation and by online command.

Change buzzer sound setting

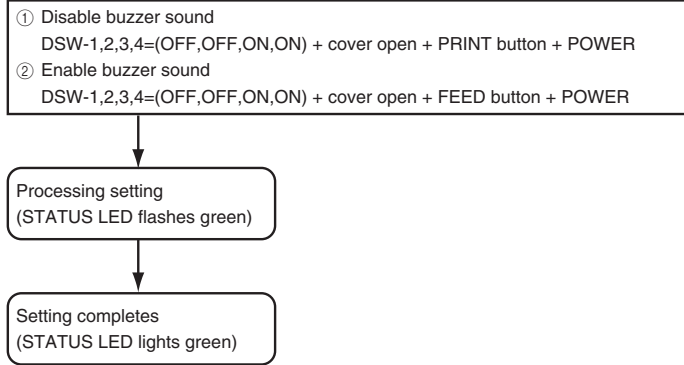

14

Reference

Note: When the buzzer sound mode is enabled, the buzzer sounds upon startup. Release the PRINT/FEED button to stop the buzzer. To check the settings for the buzzer sound setting mode, see the test print output (See P. 23). To end buzzer sound setting, confirm that the STATUS LED is on in green, then turn the power off. After changing the buzzer sound setting mode, be sure to restore the DSW to their original settings.

Standard/non-standard code setting mode

Standard code/non-standard code settings for control codes can be changed using the control code setting command.

Standard/non-standard specifications

Type	Operation	Default												
Standard code setting	The following control codes are set as standard codes.	Standard code setting												
	<table border="1"> <thead> <tr> <th>Control code</th> <th>Binary</th> </tr> </thead> <tbody> <tr> <td>STX</td> <td>02H</td> </tr> <tr> <td>ETX</td> <td>03H</td> </tr> <tr> <td>ESC</td> <td>1BH</td> </tr> <tr> <td>ENQ</td> <td>05H</td> </tr> <tr> <td>CAN</td> <td>18H</td> </tr> <tr> <td>NULL</td> <td>00H</td> </tr> </tbody> </table>		Control code	Binary	STX	02H	ETX	03H	ESC	1BH	ENQ	05H	CAN	18H
Control code	Binary													
STX	02H													
ETX	03H													
ESC	1BH													
ENQ	05H													
CAN	18H													
NULL	00H													
Non-standard code setting	The following control codes are set as non-standard codes.													
	<table border="1"> <thead> <tr> <th>Control code</th> <th>Binary</th> </tr> </thead> <tbody> <tr> <td>STX</td> <td>7BH(!)</td> </tr> <tr> <td>ETX</td> <td>7DH())</td> </tr> <tr> <td>ESC</td> <td>5EH(^)</td> </tr> <tr> <td>ENQ</td> <td>40H(@)</td> </tr> <tr> <td>CAN</td> <td>21H(!)</td> </tr> <tr> <td>NULL</td> <td>7EH(-)</td> </tr> </tbody> </table> <p>* Non-standard codes can be changed using the user download setting command.</p>		Control code	Binary	STX	7BH(!)	ETX	7DH())	ESC	5EH(^)	ENQ	40H(@)	CAN	21H(!)
Control code	Binary													
STX	7BH(!)													
ETX	7DH())													
ESC	5EH(^)													
ENQ	40H(@)													
CAN	21H(!)													
NULL	7EH(-)													

14

Reference

Change standard/non-standard code setting

The standard code/non-standard code setting is changed by the DIP switch (DSW) settings when the power is turned on, and by button settings. The settings are enabled upon turning the power off.

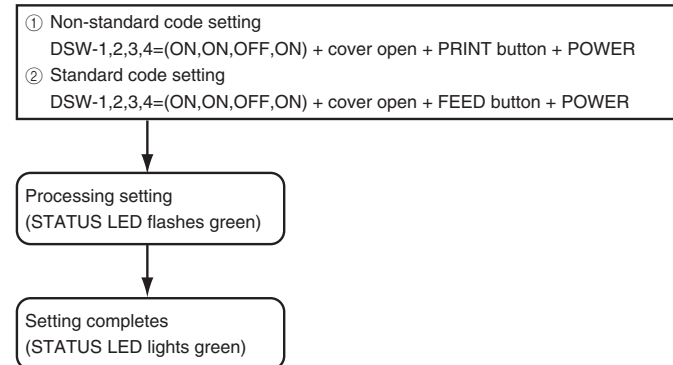

Note: When the buzzer sound mode is enabled, the buzzer sounds upon startup. Release the PRINT/FEED button to stop the buzzer. To check the settings for the standard code/non-standard code setting mode, see the test print output (See P. 23). To end standard code/non-standard code setting, confirm that the STATUS LED is on in green, then turn power off. After changing the standard code/non-standard code setting mode, be sure to restore the DSW to their original settings.

DIP Switch

• Setting DIP switch

- 1 Turn the power OFF.
- 2 Open the DIP switch cover.
- 3 Use a pointed object, such as the tip of a ballpoint pen, to change the switch position.

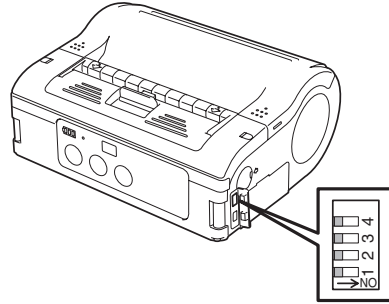

14

Reference

14

Reference

• DIP switch setting items

DIP switch				Cover	Button		Startup mode	
1	2	3	4		PRINT	FEED	Interface	Content
OFF	OFF	OFF	OFF	CLOSE	OFF	OFF	RS-232C	Normal printing mode
				CLOSE	OFF	ON	–	User test printing mode
OFF	OFF	ON	ON	CLOSE	OFF	OFF	RS-232C	HEX dump mode
				OPEN	ON	OFF	–	Buzzer sound disabled
				OPEN	OFF	ON	–	Buzzer sound enabled
OFF	OFF	OFF	ON	OPEN	ON	OFF	–	Automatic dispenser printing setting
				OPEN	OFF	ON	–	Manual dispenser printing setting
OFF	ON	OFF	OFF	CLOSE	OFF	OFF	Bluetooth interface Wireless LAN interface	Normal printing mode
				CLOSE	OFF	ON	–	User test printing mode
OFF	ON	OFF	ON	OPEN	ON	OFF	–	Head check (printing area) setting
				OPEN	OFF	ON	–	Head check disabled
OFF	ON	ON	ON	CLOSE	OFF	OFF	Bluetooth interface Wireless LAN interface	HEX dump mode
				OPEN	ON	OFF	–	CRC check enabled
				OPEN	OFF	ON	–	CRC check disabled
ON	OFF	OFF	OFF	CLOSE	OFF	OFF	Infrared interface	Normal startup mode
				CLOSE	OFF	ON	–	Test printing mode
ON	OFF	ON	ON	CLOSE	OFF	OFF	Infrared interface	HEX dump mode
ON	OFF	OFF	ON	OPEN	ON	OFF	–	Head check (Barcode printing area) setting
				OPEN	ON	OFF	–	Head check disabled
ON	ON	OFF	OFF	CLOSE	OFF	OFF	USB interface	Normal operation
				CLOSE	OFF	ON	–	Test printing mode
ON	ON	ON	ON	CLOSE	OFF	OFF	USB interface	HEX dump mode
				OPEN	ON	OFF	–	Online command setting (compatible with MB400)
				OPEN	OFF	ON	–	Online command setting (SBPL command)
ON	ON	OFF	ON	OPEN	ON	OFF	–	Non-standard code setting
				OPEN	OFF	ON	–	Standard code setting

Basic Specifications of MB400i/MB410i

Item	MB400i	MB410i
Printing method	Thermal printing	
Head density	8 dots/mm (203 dpi)	12 dots/mm (305 dpi)
Maximum effective printing area	104 mm (width) × 297 mm (pitch)	
Printing speed	Maximum 103 mm/sec. (printing speed is 75 mm/sec. during dispenser printing). Differs depending on printing rate and usage environment. Printing speed can be changed using the printing speed setting command.	
Dimensions	170 mm (width) × 76 mm (depth) × 134 mm (height) (excluding protruded parts)	
Weight	750 g or less (Standard specifications; including the battery pack)	
Power source (battery)	Pack type (lithium ion) 1700 mAh can continuously print four rolls of thermal labels (equivalent to 50 m) when fully charged (however, at a printing rate of 16% or less).	
Paper	Always use genuine SATO labels.	
Paper thickness	0.064 mm to 0.190 mm	
Paper shape	Roll media: Face-out winding Maximum outer diameter: φ 58 mm	
Label size (backing liner and eye-mark pitch)	Standard	Width 50 to 111 mm (53 to 114 mm) Pitch: 25 to 297 mm (28 to 300 mm)
	Dispenser	Width 50 to 111 mm (53 to 114 mm) Pitch: 25 to 182 mm (28 to 185 mm)
	Non-separated	Width 53 to 107 mm Pitch: 28 to 182 mm
Label printing	Continuous printing (Paper sensor enabled) Dispenser printing (Paper sensor enabled) Journal printing (Paper sensor disabled) Non-separated printing (Paper sensor enabled) Label printing can be changed using the printer command <PG>.	
Self-diagnosis function	Head check/battery check/paper out/cover open/test printing	
Low power consumption function	Enters sleep mode after five seconds of non-activity (button press, data reception or cover operation). Automatically powers off after five minutes of continued non-activity. Note: The default setting for the Bluetooth or the wireless LAN models is to disable automatic power-off. The automatic power-off time can be changed using the <PG> printer operation command. For command details, see the programming guide.	
Interface	<ul style="list-style-type: none"> • RS-232C • USB • Optical coupling • Bluetooth option • Wireless LAN option 	
	Mini DIN (specified)	
	mini B type	
	Infrared communication (compliant with IrDA Standard Ver 1.2)	
	Bluetooth Specification Ver1.1 Class2	
	Wireless LAN interface (IEEE 802.11b/g)	
	TCP/IP (FTP, LPR, SOCKET)	
Paper sensor	Reflective sensor (I-mark), transmission type (gap)	

14

Reference

Item	MB400i	MB410i
Character magnification	1 to 6 times	
Character rotation	0°, 90°, 180°, 270°	
Fonts	SATO standard fonts: ×20, ×21, ×22, ×23, ×24, OCR-A, OCR-B, POP fonts Kanji 16 × 16, 22 × 22, 24 × 24 square Gothic (JIS level-1 and level-2 set), Mark-down fonts	
Barcode	JAN/EAN8, JAN/EAN13, UPC-E/UPC-A, NW-7, CODE39, CODE93, CODE128, INTERLEAVED 2 of 5, customer barcode, RSS-14 * However, barcodes are to be used at: Parallel barcode: thin bar width 2 dots or more Serial barcode: thin bar width 3 dots or more	
2-D code	PDF417, QR code (includes micro QR), Data matrix code (ECC200), MAXI code, composite symbols	
Switch	POWER button, PRINT button, FEED button	
Display	STATUS LED: 1 (lights in three colors: green, red, and orange) Battery remaining power display LED : 3 (lights in two colors: green and red)	
Buzzer	Printer status information buzzer	
Safety or Noise standard	FCC15B, EN55022, EN55024, EN61000-3-2, EN61000-3-3, GB4943, GB9254, GB17625.1	
Protective circuit	Overcharging prevention, over-discharging prevention, head overheating protection function, low battery detection	
Water resistance	Meets IPX3 JIS C0920-2003 When using waterproof case (option) * Excludes when communication cable is connected.	
Environment conditions (including battery pack)	Operating ambient temperature : -15 to 50°C (for wireless LAN: 0 to 50°C) Humidity : 20 to 80% Non-condensing Storage ambient temperature : -25 to 60°C Humidity : 20 to 80% Non-condensing Excludes paper environment	
Options	Battery pack, AC adapter, battery charger (single), waterproof case, belt case, RS-232C cable, USB cable	

14

Reference

AVATO
DCS & Labeling Worldwide

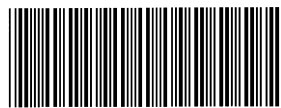

Q01662000