

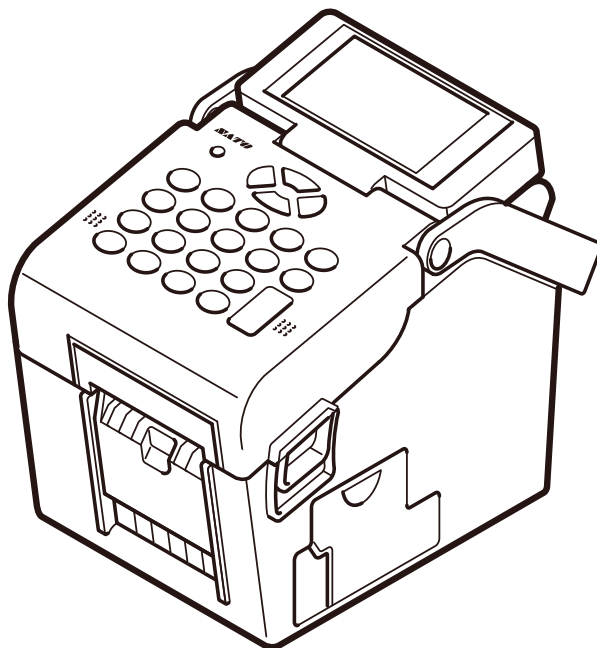

# Quick Guide

For printer model:

**TH208**



English

German

Chinese

Korean

PN: Q02544000

Read this Quick Guide before and during usage of the above product.  
Keep this document handy for future reference.

## FCC WARNING

You are cautioned that changes or modifications not expressly approved by the party responsible for compliance could void your authority to operate the equipment.

This device complies with Part 15 of the FCC Rules. Operation is subject to the following two conditions: (1) this device may not cause harmful interference, and (2) this device must accept any interference received, including interference that may cause undesired operation.

This equipment has been tested and found to comply with the limits for a Class B digital device, pursuant to Part 15 of the FCC Rules. These limits are designed to provide reasonable protection against harmful interference in a residential installation. This equipment generates, uses and can radiate radio frequency energy and, if not installed and used in accordance with the instructions, may cause harmful interference to radio communications.

However, there is no guarantee that interference will not occur in a particular installation.

If this equipment does cause harmful interference to radio or television reception, which can be determined by turning the equipment off and on, the user is encouraged to try to correct the interference by one or more of the following measures;

- Reorient or relocate the receiving antenna.
- Increase the separation between the equipment and receiver.
- Connect the equipment into an outlet on a circuit different from that to which the receiver is connected.
- Consult the dealer or an experienced radio/TV technician for help.



AC power cord with ferrite core must be used for RF interference suppression.

# Safety Precautions



This section describes how to use the printer safely. Be sure to read it carefully before using the printer.



## Pictographic Symbols



This instruction manual and the printer labels use a variety of pictographic symbols to facilitate safe and correct use of the printer and to prevent injury to others and property damage. The symbols and meanings for them are given below. Be sure to understand these symbols well before reading the main text.



















 <b>Warning</b>	Ignoring the instructions marked by this symbol and erroneously operating the printer could result in death or serious injury.
 <b>Caution</b>	Ignoring the instructions marked by this symbol and erroneously operating the printer could result in injury or property damage.

## Example Pictographs

 The  pictograph means "Caution is required." A specific warning symbol is contained inside this pictograph (The symbol at left is for electric shock).

 The  pictograph means "Should not be done." What is specifically prohibited is contained in or near the pictograph (The symbol at left means "Disassembly prohibited").

 The  pictograph means "Must be done." What is specifically to be done is contained in the pictograph (The symbol at left means "Unplug the power cord from the outlet").

 <b>Warning</b>		
<p><b>Do not set on an unstable area</b></p> <ul style="list-style-type: none"> <li> Do not set on an unstable area, such as a wobbly table or slanted area or an area subject to strong vibration. If the printer falls off or topples over, it could injure someone.</li> </ul> <p><b>Do not place containers full of water or other liquid on the printer.</b></p> <ul style="list-style-type: none"> <li> Do not place flower vases, cups, or other containers holding liquids, such as water or chemicals, or small metal objects near the printer. If they are spilled and get inside the printer, immediately turn off the power switch, unplug the power cord from the outlet, and contact the store, dealer, or Support Center. Using the printer in this condition could cause a fire or electric shock.</li> </ul> <p><b>Do not put objects inside the printer</b></p> <ul style="list-style-type: none"> <li> Do not insert or drop in metal or burnable objects inside the printer's openings (cable outlets, etc.). If foreign objects do get inside the printer, immediately turn off the power switch, unplug the power cord from the outlet, and contact the store, dealer, or Support Center. Using the printer in this condition could cause a fire or electric shock.</li> </ul> <p><b>Do not use other than the specified voltage</b></p> <ul style="list-style-type: none"> <li> Do not use other than the specified voltage. Doing so could result in fire or electric shock.</li> </ul>	<p><b>Always ground the connections</b></p> <ul style="list-style-type: none"> <li> Always connect the printer's ground wire to a ground. Not grounding the ground wire could result in electric shock.</li> </ul> <p><b>Handling of the power cord</b></p> <ul style="list-style-type: none"> <li> Do not damage, break, or modify the power cord. Also, do not place heavy objects on the power cord, heat it, or pull it because doing so could damage the power cord and cause a fire or electric shock.</li> <li> If the power cord becomes damaged (core is exposed, wires broken, etc.), contact the store, dealer, or Support Center.</li> <li> Do not modify, excessively bend, twist, or pull the power cord. Using the power cord in such a condition could cause a fire or electric shock.</li> </ul> <p><b>When the printer has been dropped or broken</b></p> <ul style="list-style-type: none"> <li> If the printer is dropped or broken, immediately turn off the power switch, unplug the power cord from the outlet, and contact the store, dealer, or Support Center. Using the printer in this condition could cause a fire or electric shock.</li> <li> Using the printer in this condition could cause a fire or electric shock.</li> <li> Unplug the power cord from the outlet.</li> </ul>	<p><b>Do not use the printer when something is abnormal about it</b></p> <ul style="list-style-type: none"> <li> Continuing to use the printer in the event something is abnormal about it, such as smoke or unusual smells coming from it, could result in fire or electric shock. Immediately turn off the power switch, unplug the power cord from the outlet, and contact the store, dealer, or Support Center for repairs. It is dangerous for the customer to try to repair it, so absolutely do not attempt repairs on your own.</li> <li> Unplug the power cord from the outlet.</li> </ul> <p><b>Do not disassemble the printer</b></p> <ul style="list-style-type: none"> <li> Do not disassemble or modify the printer. Doing so could result in fire or electric shock. Ask the store, dealer, or Support Center to conduct internal inspections, adjustments, and repairs.</li> <li> Using the printer in this condition could cause a fire or electric shock.</li> </ul> <p><b>Regarding the cutter</b></p> <ul style="list-style-type: none"> <li> Do not touch the cutter with your hands or do not put something into the cutter. Doing so could result in an injury.</li> </ul> <p><b>Using the head cleaning fluid</b></p> <ul style="list-style-type: none"> <li> Use of flame or heat around the head cleaning fluid is prohibited. Absolutely do not heat it or subject it to flames.</li> <li> Keep the fluid out of reach of children to prevent them from accidentally drinking it. If the fluid is drunk, immediately consult with a physician.</li> </ul>

# Safety Precautions

## ⚠ Warning

### Battery Pack



- Never try to take apart the battery pack or modify it in any way such as with a solder iron.
- Never expose the battery to direct flame, throw it into fire, or take any actions that may lead to shorting.
- When charging the battery pack, make sure to use the printer or the specified battery charger.

### AC Adapter/Battery Charger (Option)



- Use only the specified voltage. Using a different voltage may create the danger of fire or electric shock.
- Use only the specified AC adapter. Using a different one may create the danger of fire or electric shock.
- Never use the battery charger with any other battery pack except for the specified one. Doing so can rupture the battery, cause leakage, fire or electric shock.
- Never cut, damage or modify the power cord. Also, never place heavy objects on the power cord or heat or pull the power cord. Doing so may damage the cord and create the danger of fire or electric shock.
- Should the power cord ever become seriously damaged (internal wiring exposed or shorted), contact your nearest dealer or service center for repair. Continued use of such a cord creates the danger of fire or electric shock.
- Never modify, excessively bend, twist, or pull the power cord. Doing so creates the danger of fire or electric shock.

English

## ⚠ Caution

### Do not place in areas with high humidity



- Do not place the printer in areas with high humidity or where condensation forms. If condensation forms, immediately turn off the power switch and do not use the printer until it dries. Using the printer while condensation is on it could result in electric shock.

### Carrying the Printer



- When moving the printer, always unplug the power cord from the outlet and check to make sure all external wires are disconnected before moving it. Moving the printer with the wires still connected could damage the cords or connecting wires and result in a fire or electrical shock.
- Do not carry the printer with paper loaded in it. The paper could fall out and cause an injury.
- When setting the printer on the floor or a stand, make sure not to pinch your fingers or hands under the printer feet.

### Power supply



- Do not operate the power switch or plug in/unplug the power cord with wet hands. Doing so could result in electric shock.

### Power cord



- Keep the power cord away from hot devices. Getting the power cord close to hot devices could cause the cord's covering to melt and cause a fire or electrical shock.
- When unplugging the power cord from the outlet, be sure to hold it by the plug. Pulling it by the cord could expose or break the core wires and cause a fire or electric shock.
- The power cord set that comes with the printer is especially made for this printer. Do not use it with any other electrical devices.

### Cover



### Print head



- Be careful not to pinch your fingers when opening or closing the cover. Also be careful the cover does not slip off and drop.
- The print head is hot after printing. Be careful not to get burned when replacing paper or cleaning immediately after printing.
- Touching the edge of the print head with bare hands could result in injury. Be careful not to become injured when replacing paper or cleaning.
- The customer should not replace the print head. Doing so could result in injury, burns, or electric shock.

### Loading paper



- When loading roll paper, be careful not to get your fingers pinched between the paper roll and the supply unit.

### When not using the printer for a long time



- When not using the printer for a long time, unplug the power cord from the outlet to maintain safety.

### During maintenance and cleaning



- When maintaining and cleaning the printer, unplug the power cord from the outlet to maintain safety.

### Lithium coin battery



- Risk of explosion if battery is replaced by an incorrect type.
- Dispose of used batteries according to the instructions.

 **Caution**

**Replacing the Battery Pack**



- Use only the specified battery pack.
- When replacing the battery pack, make sure to install the pack in the correct orientation. Incorrectly replacing the battery creates the danger of explosion, injury or damage to surrounding areas.
- Replacing a small-size rechargeable battery (Lithium ion battery)  
Apply insulation treatment for the old battery pack by sealing the contact with tape or the like and ask our sales representative or service center for the measures to be taken to recycle the reusable materials.  
Do not place the battery pack together with other batteries such as dry batteries.

**Caution**

- (1) Reproduction in any manner of all or part of this document is prohibited.
- (2) The contents of this document may be changed without prior notice.
- (3) Great care has been taken in the preparation of this document, but if any problems, mistakes, or omission are found, please contact the store or dealer where you purchased the printer.

# Precautions for Installation and Handling

Printer operation can be affected by the printer environment.  
Refer to the following instructions for installation and handling of TH208.

## Select a Safe Location

### Place the printer on a surface that is flat and level.



If the surface is not flat and level, this may result in poor print quality. This may also cause malfunction and shorten the life span of the printer.

### Keep the printer out of high temperature and humidity.



Avoid locations subject to extreme or rapid changes in temperature or humidity. Exposure to these conditions may cause electrical problems within the printer.

### Do not place the printer on a location that produces vibration.



Do not carry the printer when the roll label is set. Giving serious vibration or shock to the printer may cause malfunction and shorten the life span of the printer.

### Do not place the printer in a location subject to water or oil.



Do not place the printer in a location where it will be splashed with water or oil. Water or oil entering inside the printer may cause a fire, electric shock, or malfunction.

### Do not place the printer near crane or pressing machine.



Machineries such as crane and pressing machine require large amount of power. This may cause electrical noise or voltage reduction. Avoid such locations to reduce the risk of malfunction or damage to the printer.

### Avoid dust.



Dust buildup may result in poor print quality. This may cause not only malfunction but also shorten the life span of the printer.

### Keep out of direct sunlight.



This printer has a built-in optical sensor. Exposure to direct sunlight will make the sensor less responsive and may cause the label to be sensed incorrectly. Close the cover when printing.

## Power Supply (When using an AC adapter)

### This printer requires an AC power supply.



Be sure to connect the printer to an AC power supply via the supplied AC adapter. Failure to do so may result in miss operation or a malfunction.

### Provide a stable source of electricity to the printer.

Do not share the power outlets with other appliances such as a heater and refrigerator requiring a measurable amount of power. Also, avoid using the power outlet near where such appliances are plugged into. This may cause voltage reduction and malfunction.

### Connect the power cord to a grounded power outlet.



Make sure to have the facility equipped with the ground slot.

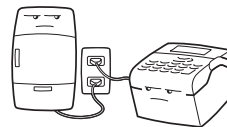

# Table of Contents

<b>Safety Precautions</b> .....	3
<b>Precautions for Installation and Handling</b> .....	6
<b>Names of Parts</b> .....	9
<b>Preparing for First-time Operation</b> .....	12
<b>Turning on the Power</b> .....	16
<b>Basic Specifications</b> .....	18

## Checking Accessories

Make sure that you have received all of the following items in the package. If there are any accessories missing, contact your nearest dealer or the store where you purchased the printer.

Leaflet (Global warranty)

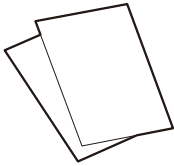

Quick Guide



AC power cord

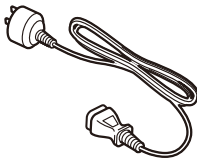

AC adapter

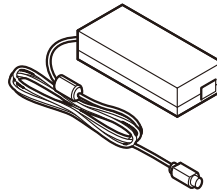

English

### About the Box

Please retain both the box in which the printer was packed and the cushioning material (cushions that hold the printer in place). If you need to send in the printer for repair, repack it in this box.

# Names of Parts

## ▲ Printer Unit (Unit Exterior)

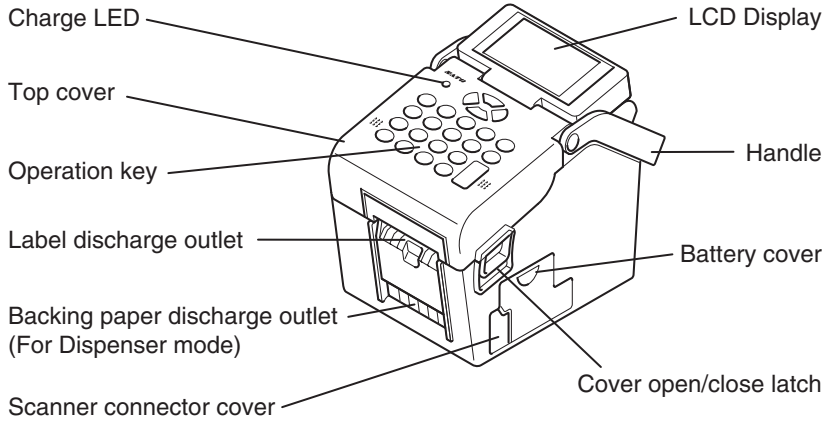

English

## ▲ Back (USB Interface)

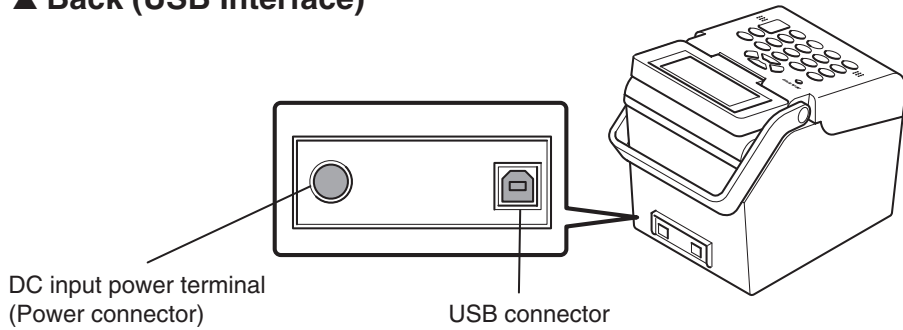

## ▲ Back (USB + LAN Interface)

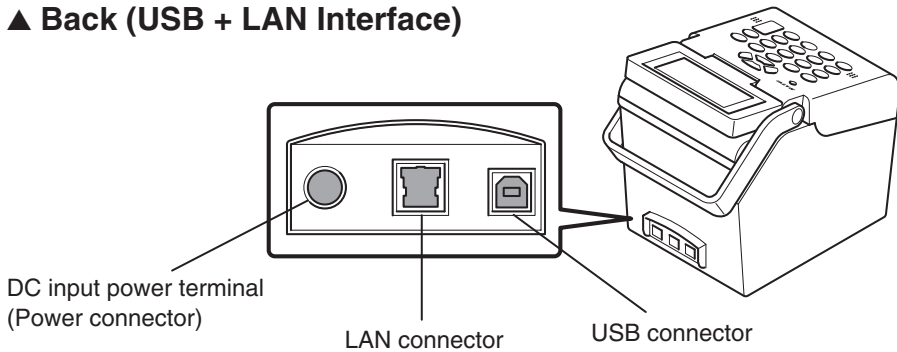

## Names of Parts

### When Top Cover Is Opened

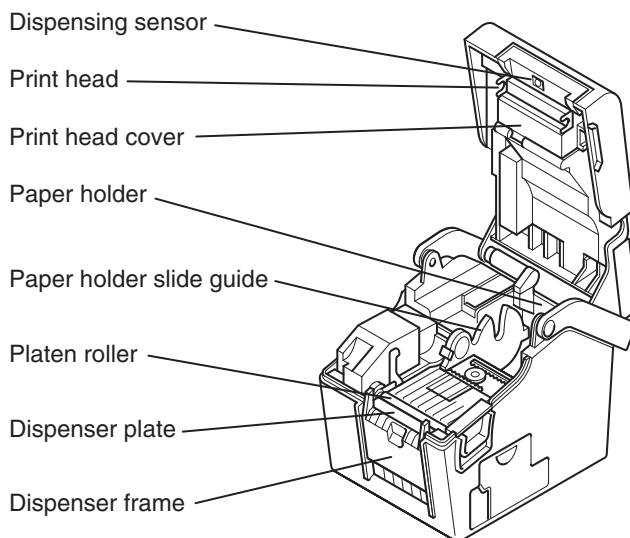

English

### Cutter Type (Optional)

Cutter type

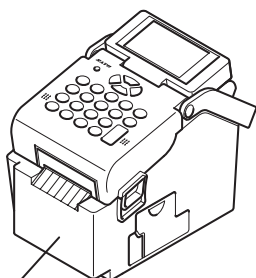

Cutter unit

Cutter type for linerless label

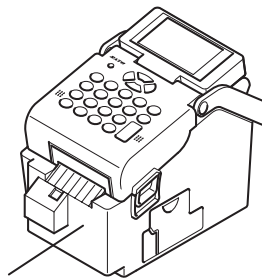

Cutter unit for linerless label

\* There is no difference in the unit exterior between standard type and non-cutter type for linerless label.

**⚠ CAUTION**

The cutter is sharp. Be careful not to cut your hands.

## ▲ Operation Panel

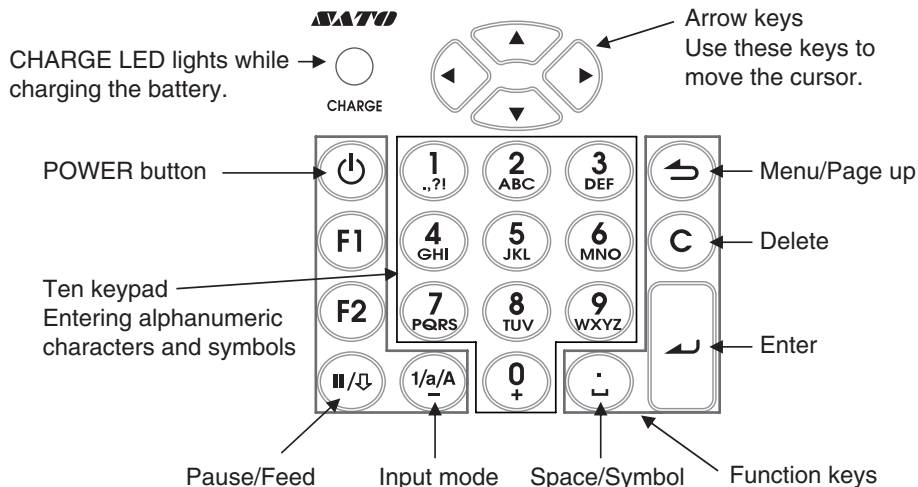

## Function keys

<b>POWER button</b>	<b>Power ON:</b> Hold down for 1 second. <b>Power OFF:</b> Hold down for more than 3 seconds.
<b>Menu/Page up</b>	Goes to the initial screen or up one level <b>[Menu]</b> Hold down for more than 1 second to go back to main menu. <b>[Page up]</b> Press once to go up one level.
<b>Delete</b>	Deletes characters. Press once for deleting the character to the left of the line cursor. Hold down for deleting the entire row of input characters.
<b>F1</b>	Access to a menu with a list of predefined short cuts such as [1.Date setting], [2.Test print], [3.LCD contrast] and [4.Darkness] etc.
<b>F2</b>	Input mode/press once: Scroll mode. Scrolls within a column by pressing an arrow key. Input mode/press twice: Jump mode. Jumps between columns in a table by pressing an arrow key.
<b>Pause/Feed</b>	<b>[Pause]</b> Print mode/press once: Stops print job/cancels print job. Print mode/press again: Feeds label. <b>[Feed]</b> Feeds one label.
<b>Input mode</b>	Toggles between different input modes. <b>[1]</b> Numeric input (default) <b>[a]</b> Lower case input <b>[A]</b> Upper case input
<b>Space/Symbol</b>	Enters space/symbols such as [.] [,] [:] [\$] [@] ["] [_ (space)] [€] [£] [\$] [¥]
<b>Enter</b>	Confirms an input sequence. Confirms a selection in a menu list.

# Preparing for First-time Operation

## Charging the Battery Pack

- **Charging by installing the battery pack in the battery charger (optional)**  
Install the battery pack in the battery charger (optional) and charge it.



The optional battery charger set provided for this printer is specific to this printer. Do not use it for other electric equipment.

English

- 1 Connect the power cord from the AC adapter to the charger unit. Then, connect the power cord to the AC adapter and plug it to the outlet.

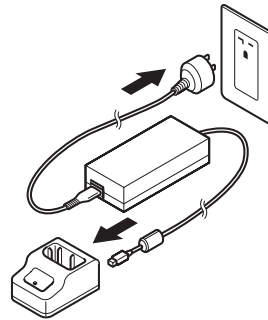

- 2 Insert the battery pack into the slot, with the terminal pointing downward.

- When charging begins, the CHARGE lamp (red) lights. When charging is complete, the CHARGE lamp lights green (fully charged).

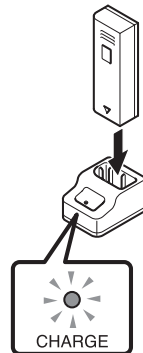

- 3 Remove the battery pack when charging is complete.

### Charging time

It takes about 1.5 hours for the CHARGE lamp to turn green when charging a completely depleted battery.

---

**Note**

- When the CHARGE lamp is not lit, check that the battery pack is installed securely.  
The battery may not be charged when not securely installed.
  - When a charged battery pack is installed, the CHARGE lamp first lights red, then lights green.
- 

**• Charging by installing the supplied AC adapter on the printer**

This charges the battery pack while it is installed in the printer.



The AC adapter set provided for this printer is specific to this printer.  
Do not use it for other electric equipment.  
Use only power supplies listed in the Basic Specifications.

English

1. Insert the DC power cord into the DC input terminal.
2. Connect the power cord to the AC adapter and plug it to the outlet.

When charging begins, the CHARGE LED lights.

When charging is complete, the CHARGE LED turns off (fully charged).

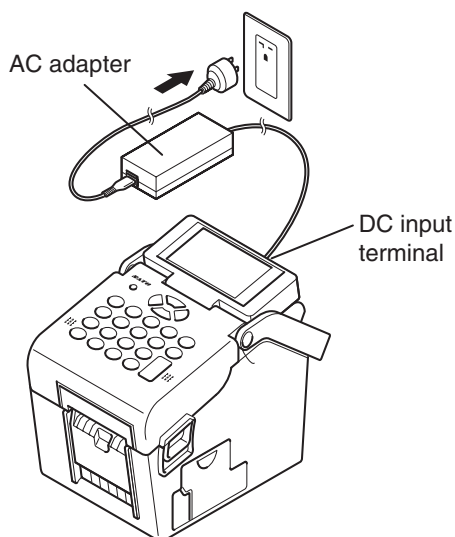
**Charging time**

It takes about 6 hours for the CHARGE LED to turn off when charging a completely depleted battery.

## Preparing for First-time Operation

### Installing and Removing the Battery Pack

1. Open the battery cover.

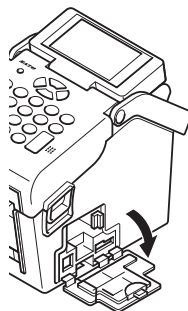

2. Insert the battery pack, then close the battery cover.  
Insert the battery pack with the terminal side toward the printer.

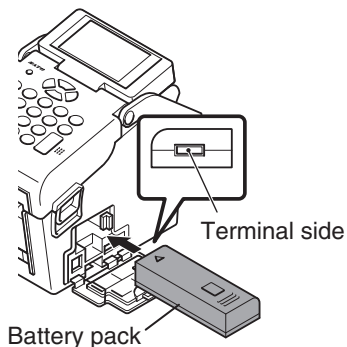

3. To remove the battery pack, press the blue hook to unlock it, then hold the tab and pull out the battery pack.

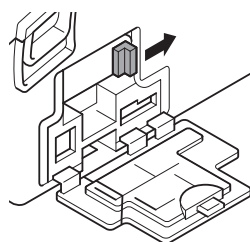

#### **⚠ CAUTION**

\*Be sure to turn the power off before removing or replacing the battery pack.

When the power is off, the LCD display turns off. Do not remove the battery pack until the LCD display turns off.

\*Note that removing the battery pack by the operation above may prevent updating the Information in the printer memory.

## Using AC Adapter

Install the supplied AC adapter on the printer for use.



The AC adapter set provided for this printer is specific to this printer. Do not use it for other electric equipment. Use only power supplies listed in the Basic Specifications.

1. Insert the DC output terminal into the DC input terminal.

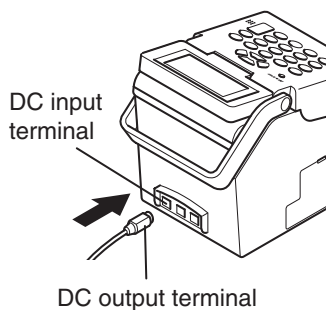

2. Connect the AC adapter into the outlet.

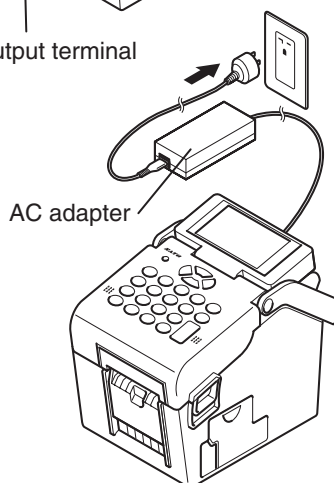

### CAUTION

- \*Be sure to turn the printer power off before detaching the DC output terminal of the AC adapter, or disconnecting the power supply.
- \*Note that disconnecting the power supply in ways other than described above may prevent the printer from correctly storing any settings in memory.
- \*No battery pack is necessary when the AC adapter is used. When the battery pack and AC adapter are used simultaneously, charging begins if the battery is not fully charged.

# Turning On the Power

## Power Setting

Plug the DC power cord of the AC adapter into the printer and turn on the power.

1. Connect the AC power cord to the AC adapter.

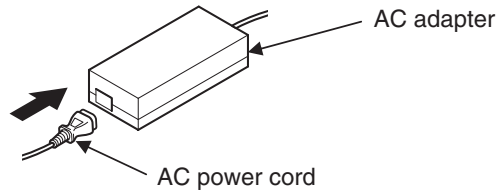

2. Connect the printer → AC adapter → AC power outlet.  
When plugging the DC power cord into the printer's power connector, make sure the DC power cord connector is oriented properly.  
When plugging in the DC power cord to the printer, use one hand to hold the printer while using the other hand to plug in the cord.

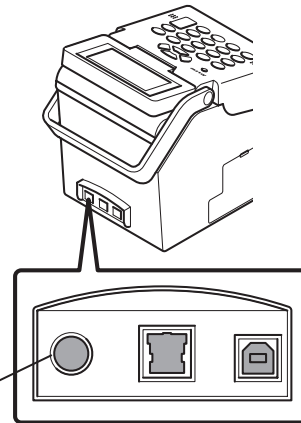

DC input power terminal  
(Power connector)

Make sure the flat side of the  
DC power cord is facing up.

DC power cord

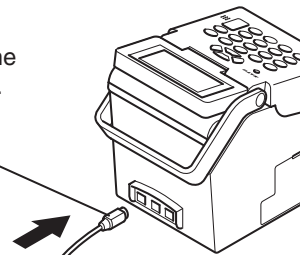

- 
3. Press the POWER button on the operation panel of the unit. The LCD display is lit when the printer is turned on.

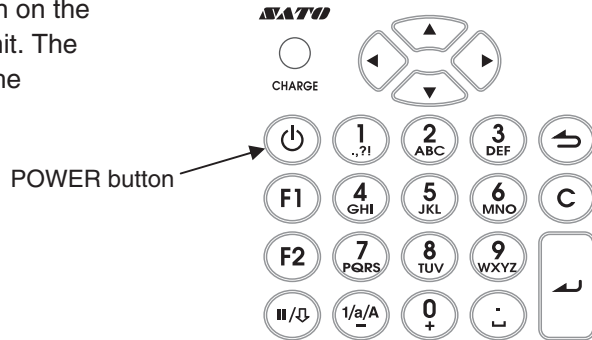

- 
4. Hold down the POWER button for more than 3 seconds to turn off the printer. When the power is off, the LCD display turns off.

**⚠ CAUTION**

- \*The power cord set supplied with this printer is only for use with this printer. Do not use it for other electrical products.
- \*Do not operate the POWER button or plug in/unplug the power cord with wet hands. Doing so could result in electric shock.

# Basic Specifications

Model name	TH208
Printing method	Direct thermal
Head density (Resolution)	203dpi (8-dot/mm)
Printing effective area	156mm pitch x 56mm wide (6.1" pitch x 2.2" wide)
Unprintable area	Length direction Upper: 2.0mm (0.07") Lower: 2.0mm (0.07") (Not including backing paper) Width direction Left: 1.5mm (0.05") Right: 1.5mm (0.05") (Not including backing paper)
Printing speed	50 to 100mm/sec (2 to 4 inches/sec) * Printing speed differs depending on paper type and usage environment.
Paper type/Paper shape	Roll paper (Winding face-in/face-out) Recommended use of paper manufactured or specified by SATO.
Paper thickness	140 to 190 $\mu$ m (0.14 to 0.19mm/0.005 to 0.007")
Label size	<p><b>Continuous type</b> [Die cut label] Pitch: 16 to 156mm/0.6 to 6.1" (Backing paper 19 to 159mm/0.7 to 6.2") Width: 25 to 60mm/0.9 to 2.3" (Backing paper 28 to 63mm/1.1 to 2.4") [Butt-cut label] Pitch: 16 to 156mm/0.6 to 6.1" (Backing paper 16 to 156mm/0.6 to 6.1") Width: 28 to 60mm/1.1 to 2.3" (Backing paper 28 to 60mm/1.1 to 2.3")</p> <p><b>Cutter type</b> [Die cut label] Pitch: 16 to 156mm/0.6 to 6.1" (Backing paper 19 to 159mm/0.7 to 6.2") Width: 25 to 60mm/0.9 to 2.3" (Backing paper 28 to 63mm/1.1 to 2.4")</p> <p><b>Tear-off type</b> [Die cut label] Pitch: 16 to 156mm/0.6 to 6.1" (Backing paper 19 to 159mm/0.7 to 6.2") Width: 25 to 60mm/0.9 to 2.3" (Backing paper 28 to 63mm/1.1 to 2.4") [Butt-cut label] Pitch: 16 to 156mm/0.6 to 6.1" (Backing paper 16 to 156mm/0.6 to 6.1") Width: 28 to 60mm/1.1 to 2.3" (Backing paper 28 to 60mm/1.1 to 2.3")</p> <p><b>Dispenser type</b> [Die cut label] Pitch: 16 to 117mm/0.6 to 4.6" (Backing paper 16 to 120mm/0.6 to 4.7") Width: 25 to 60mm/0.9 to 2.3" (Backing paper 28 to 63mm/1.1 to 2.4") [Butt-cut label] Pitch: 16 to 117mm/0.6 to 4.6" (Backing paper 16 to 117mm/0.6 to 4.6") Width: 28 to 60mm/1.1 to 2.3" (Backing paper 28 to 60mm/1.1 to 2.3")</p> <p><b>Linerless type (without cutter)</b> Pitch: 25.4 to 100mm/1 to 3.9" Width: 28 to 60mm/1.1 to 2.3"</p> <p><b>Linerless type (with cutter)</b> Pitch: 45 to 100mm/1.7 to 3.9" Width: 28 to 60mm/1.1 to 2.3"</p>
Outer diameter of paper roll / Internal diameter of roll core	Outer diameter: Maximum $\phi$ 75mm ( $\phi$ 2.9") Internal diameter: $\phi$ 26mm ( $\phi$ 1.0")

\*Some restrictions may apply to the paper sizes that can be used depending on the type of paper, usage environment, and application.



## Basic Specifications

Barcode	(1)UPC-A/E, JAN/EAN-8/13 (2)CODE39 (3)CODE128A/B/C, GS1-128 (UCC/EAN128) (4)Codabar (NW-7) (5)Interleaved 2 of 5 (6)BOOKLAND (2-5 char add-on code) (7)GS1 DataBar (RSS-14)
2D barcode	QR Code (Including Ver.8.1 Micro QR) Datamatrix
Resident embedded bitmap fonts	M 13 x 20, S 8 x 15, U + XU 5 x 9 (alphanumeric and symbols) X1 20 x 50 (alphanumeric and symbols) X2 8 x 20 (alphanumeric and symbols) X3 13 x 21 (alphanumeric and symbols) OCR-B 20 x 24 (alphanumeric in upper case) Price font 16 x 24 (numeric, period, currency marks) POP1 28 x 48 (numeric, comma, currency marks) POP2 48 x 68 (numeric, comma, currency marks) POP3 26 x 56 (numeric, comma, currency marks) Support subscript (numeric only): X1, X2, X3
Resident True Type fonts	Sato Sans, Sato Serif
Printing direction (Characters/Barcode)	<b>Characters:</b> 0°, 90°, 180°, 270° <b>Barcode:</b> Parallel 1 (0°), Parallel 2 (180°), Serial 1 (90°), Serial 2 (270°) True Type text can be rotated 0 to 359° (1° increment).
Barcode ratio	1:2, 1:3, 2:5, Free specification
Magnification ratio (Characters/Barcode/Image)	<b>Characters:</b> Vertical 1 to 4 times, Horizontal 1 to 4 times <b>Barcode:</b> 1:2, 1:3: 2 to 4 times, 2:5: 2 to 4 times
Self-diagnostic function	(1)Broken head element check (2)Paper end detection (3)Test print (4)Cover open detection (5)Calendar check (6)Calendar battery check (7)Battery check (8)Cutter error
Noise (EMC) standard	FCC15B Class B
Safety standards	UL60950-1(2001) CSA22.2 No.60950-1-03
Wireless standards Wireless LAN (2.45 GHz)	FCC15B/FCC15C

**Notice regarding the registered trademarks and trademarks of other companies**  
QR Code is a registered trademark of DENSO WAVE INCORPORATED.